



www.CrossCreekTractor.com

Call Us: 1 (800) 462-7335

AFTERMARKET TRACTOR PARTS FOR

JOHN DEERE

**ALL PARTS LISTED ARE AFTERMARKET REPLACEMENT PARTS AND ARE NOT
PRODUCED BY THE ORIGINAL EQUIPMENT MANUFACTURER**



Contents - John Deere

Clutch	162	Shop Manuals.....	186
Cooling	159	Steering, Add On Kits	170
Differential	166	Steering, Drag Links.....	170
Electrical.....	157	Steering, Misc.....	171
Engine, Balancer Shafts.....	150	Steering, Steering Valves	171
Engine, Camshafts	149	Tach Cables.....	179
Engine, Connecting Rods.....	151	Transmission	163
Engine, Crankshafts	148	Wheels & Rims	184
Engine, Flywheels	150		
Engine, Misc.....	152		
Engine, Overhaul Kits.....	112		
Front Axle, Spindles & Hubs.....	172		
Front Axle, Tie Rod Ends.....	168		
Fuel.....	154		
Hydraulics, Hitch.....	178		
Hydraulics, Hydraulic Pumps.....	174		
Hydraulics, Lines & Filters.....	177		
Hydraulics, Load Shafts.....	176		
Hydraulics, Pump Parts	173		
Manifolds & Mufflers	153		
PTO	163		
Seats	183		
Sheet Metal	180		



John Deere

ENGINE, OVERHAUL KITS

**JD 820, 1020, 1030, 300, 300A, 350, 350B, 380
3.152 3 Cylinder Diesel Engine**

EOKJD3152A

Engine Overhaul Kit
Contains Sleeves, Pistons, Rings, Sleeve Seals,
Piston Pin Bushings, Complete Gasket Set,
Front and Rear Crankshaft Seals

(Order Bearings Separately)

O-rings on Liner
3.86" Bore, 1.185" Pin
Block Numbers: T24963, T26935

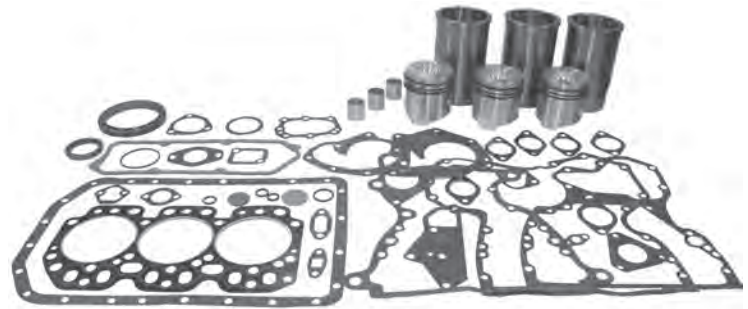

Order Individual Parts Below

PLK481

Piston and Sleeve Set
O-rings on Liner
3.86" Bore
1.185" Pin



RE27348

Rod Bearing STD (Order 3)

RE27349

Rod Bearing .010 (Order 3)

RE27358

Rod Bearing .020 (Order 3)

RE27364

Rod Bearing .030 (Order 3)



RE27352

Main Bearing STD (Order 3)

RE27353

Main Bearing .010 (Order 3)

RE27360

Main Bearing .020 (Order 3)

RE27368

Main Bearing .030 (Order 3)



AT21139

Main Thrust Bearing STD (Order 1)

AT21132

Main Thrust Bearing .010 (Order 1)

AT21134

Main Thrust Bearing .020 (Order 1)

AT21136

Main Thrust Bearing .030 (Order 1)



RE37492

Overhaul Gasket Set



RE37489

Head Gasket Set

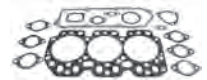

R97341

Oil Pan Gasket



AR67942

Front Crankshaft Seal



RE24959

Rear Crankshaft Seal



T23471

Piston Pin Bushing



R74194

Conn Rod Bolt



R79623

Intake Valve

R79624

Exhaust Valve



RE35685

Oil Pump





ENGINE, OVERHAUL KITS

John Deere

JD 820, 830, 1020, 1030, 300, 300A, 350, 350B, 380
3.152 3 Cylinder Diesel Engine

EOKJD3152B

Engine Overhaul Kit

Contains Sleeves, Pistons, Rings, Sleeve Seals,
Piston Pin Bushings, Complete Gasket Set,
Front and Rear Crankshaft Seals

(Order Bearings Separately)

O-rings in Block
3.86" Bore, 1.185" Pin
Block Numbers: R53240, R55100,
R72967, T32339

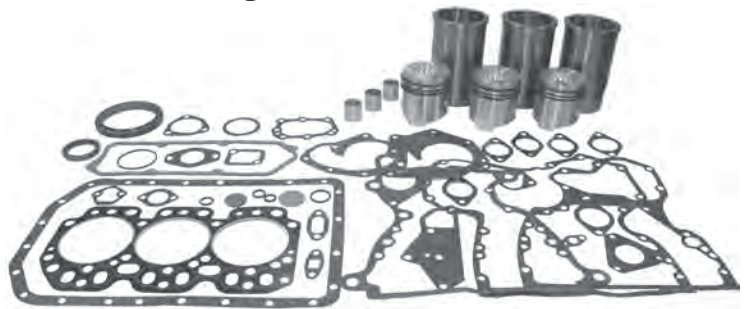

Order Individual Parts Below

AR71591

Piston and Sleeve Set
O-rings in Block
3.86" Bore
1.185" Pin



RE27348

Rod Bearing STD (Order 3)

RE27349

Rod Bearing .010 (Order 3)

RE27358

Rod Bearing .020 (Order 3)

RE27364

Rod Bearing .030 (Order 3)



RE27352

Main Bearing STD (Order 3)

RE27353

Main Bearing .010 (Order 3)

RE27360

Main Bearing .020 (Order 3)

RE27368

Main Bearing .030 (Order 3)



AT21139

Main Thrust Bearing STD (Order 1)

AT21132

Main Thrust Bearing .010 (Order 1)

AT21134

Main Thrust Bearing .020 (Order 1)

AT21136

Main Thrust Bearing .030 (Order 1)



RE38570

Overhaul Gasket Set



RE38848

Head Gasket Set

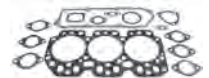

R97341

Oil Pan Gasket



AR67942

Front Crankshaft Seal



RE24959

Rear Crankshaft Seal



T23471

Piston Pin Bushing



R74194

Conn Rod Bolt



R79623

Intake Valve

R79624

Exhaust Valve



RE35685

Oil Pump





John Deere

ENGINE, OVERHAUL KITS

**JD 1520, 302, 302A
3.164 3 Cylinder Diesel Engine**

EOKJD3164A

Engine Overhaul Kit
Contains Sleeves, Pistons, Rings, Sleeve Seals,
Piston Pin Bushings, Complete Gasket Set,
Front and Rear Crankshaft Seals

(Order Bearings Separately)

O-rings on Liner
4.02" Bore
1.185" Pin

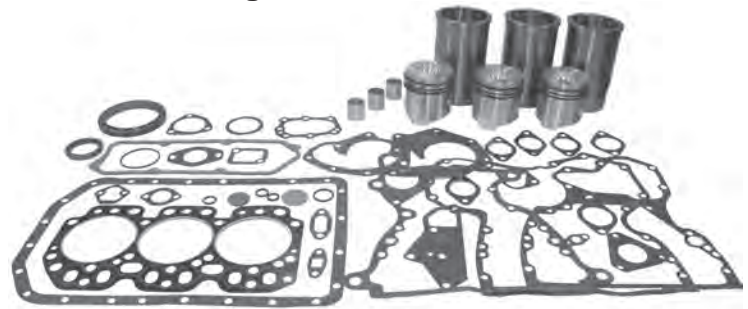

Order Individual Parts Below

PLK310

Piston and Sleeve Set
O-rings on Liner
4.02" Bore
1.185" Pin



RE27348

Rod Bearing Std (Order 3)

RE27349

Rod Bearing .010 (Order 3)

RE27358

Rod Bearing .020 (Order 3)

RE27364

Rod Bearing .030 (Order 3)



RE27352

Main Bearing Std (Order 3)

RE27353

Main Bearing .010 (Order 3)

RE27360

Main Bearing .020 (Order 3)

RE27368

Main Bearing .030 (Order 3)



AT21139

Main Thrust Bearing Std (Order 1)

AT21132

Main Thrust Bearing .010 (Order 1)

AT21134

Main Thrust Bearing .020 (Order 1)

AT21136

Main Thrust Bearing .030 (Order 1)



RE37492

Overhaul Gasket Set



RE37489

Head Gasket Set

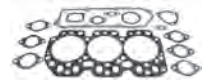

R97341

Oil Pan Gasket



AR67942

Front Crankshaft Seal



RE24959

Rear Crankshaft Seal



T23471

Piston Pin Bushing



R74194

Conn Rod Bolt



R79623

Intake Valve

R79624

Exhaust Valve



RE35685

Oil Pump





ENGINE, OVERHAUL KITS

John Deere

**JD 1520, 1530, 350B
3.164 3 Cylinder Diesel Engine**

EOKJD3164B

Engine Overhaul Kit

Contains Sleeves, Pistons, Rings, Sleeve Seals,
Piston Pin Bushings, Complete Gasket Set,
Front and Rear Crankshaft Seals

(Order Bearings Separately)

O-rings in Block
4.02" Bore
1.185" Pin

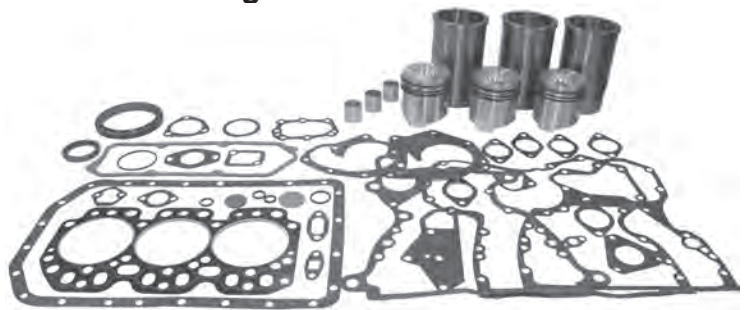

Order Individual Parts Below

AR71593

Piston and Sleeve Set
O-rings in Block
4.02" Bore
1.185" Pin



RE27348

Rod Bearing Std (Order 3)

RE27349

Rod Bearing .010 (Order 3)

RE27358

Rod Bearing .020 (Order 3)

RE27364

Rod Bearing .030 (Order 3)



RE27352

Main Bearing Std (Order 3)

RE27353

Main Bearing .010 (Order 3)

RE27360

Main Bearing .020 (Order 3)

RE27368

Main Bearing .030 (Order 3)



AT21139

Main Thrust Bearing Std (Order 1)

AT21132

Main Thrust Bearing .010 (Order 1)

AT21134

Main Thrust Bearing .020 (Order 1)

AT21136

Main Thrust Bearing .030 (Order 1)



RE37492

Overhaul Gasket Set



RE37489

Head Gasket Set

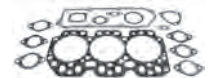

R97341

Oil Pan Gasket



AR67942

Front Crankshaft Seal



RE24959

Rear Crankshaft Seal



T23471

Piston Pin Bushing



R74194

Conn Rod Bolt



R79623

Intake Valve

R79624

Exhaust Valve



RE35685

Oil Pump





John Deere

ENGINE, OVERHAUL KITS

**JD 1530, 2040, 301A, 302, 302A, 310, 350B, 350C, 350D
3.164 3 Cylinder Diesel Engine**

EOKJD3164C

Engine Overhaul Kit
Contains Sleeves, Pistons, Rings, Sleeve Seals,
Piston Pin Bushings, Complete Gasket Set,
Front and Rear Crankshaft Seals

(Order Bearings Separately)

O-rings in Block
4.02" Bore
1.375" Pin

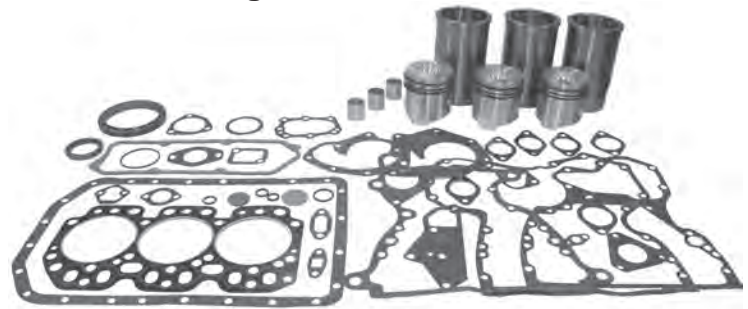

Order Individual Parts Below

AR78041

Piston and Sleeve Set
O-rings in Block
4.02" Bore
1.375" Pin



RE27348

Rod Bearing Std (Order 3)

RE27349

Rod Bearing .010 (Order 3)

RE27358

Rod Bearing .020 (Order 3)

RE27364

Rod Bearing .030 (Order 3)



RE27352

Main Bearing Std (Order 3)

RE27353

Main Bearing .010 (Order 3)

RE27360

Main Bearing .020 (Order 3)

RE27368

Main Bearing .030 (Order 3)



AT21139

Main Thrust Bearing Std (Order 1)

AT21132

Main Thrust Bearing .010 (Order 1)

AT21134

Main Thrust Bearing .020 (Order 1)

AT21136

Main Thrust Bearing .030 (Order 1)



RE37492

Overhaul Gasket Set



RE37489

Head Gasket Set

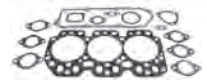

R97341

Oil Pan Gasket



AR67942

Front Crankshaft Seal



RE24959

Rear Crankshaft Seal



R55647

Piston Pin Bushing



R74194

Conn Rod Bolt



R79623

Intake Valve



R79624

Exhaust Valve



RE35685

Oil Pump





ENGINE, OVERHAUL KITS

John Deere

JD 1040, 1140, 1630, 2040, 2155, 2240, 350D, 355D
3.179 3 Cylinder Diesel Engine

EOKJD3179A

Engine Overhaul Kit
Contains Sleeves, Pistons, Rings, Sleeve Seals,
Piston Pin Bushings, Complete Gasket Set,
Front and Rear Crankshaft Seals

(Order Bearings Separately)

O-rings in Block
4.19" Bore
1.375" Pin

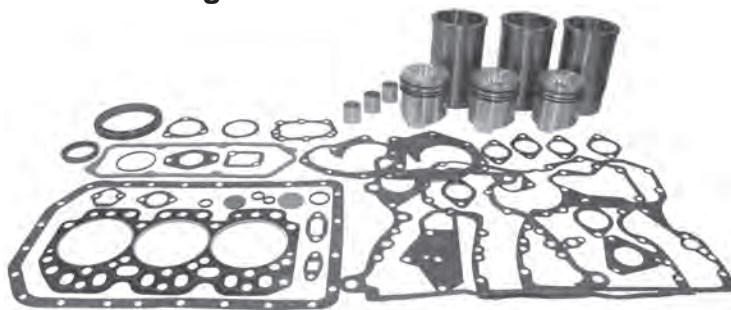

Order Individual Parts Below

RE30250

Piston and Sleeve Set
O-rings in Block
4.19" Bore
1.375" Pin



RE27348

Rod Bearing Std (Order 3)

RE27349

Rod Bearing .010 (Order 3)

RE27358

Rod Bearing .020 (Order 3)

RE27364

Rod Bearing .030 (Order 3)



RE27352

Main Bearing Std (Order 3)

RE27353

Main Bearing .010 (Order 3)

RE27360

Main Bearing .020 (Order 3)

RE27368

Main Bearing .030 (Order 3)



AT21139

Main Thrust Bearing Std (Order 1)

AT21132

Main Thrust Bearing .010 (Order 1)

AT21134

Main Thrust Bearing .020 (Order 1)

AT21136

Main Thrust Bearing .030 (Order 1)



RE37492

Overhaul Gasket Set



RE37489

Head Gasket Set



R97341

Oil Pan Gasket



AR67942

Front Crankshaft Seal



RE24959

Rear Crankshaft Seal



R55647

Piston Pin Bushing



R80033

Conn Rod Bolt



R79623

Intake Valve

R79624

Exhaust Valve



RE35685

Oil Pump





John Deere

ENGINE, OVERHAUL KITS

**JD 2355, 310C, 315C
3.179T 3 Cylinder Diesel Engine**

EOKJD3179B

Engine Overhaul Kit

Contains Sleeves, Pistons, Rings, Sleeve Seals,
Piston Pin Bushings, Complete Gasket Set,
Front and Rear Crankshaft Seals

(Order Bearings Separately)

O-rings in Block
4.19" Bore
1.6" Pin

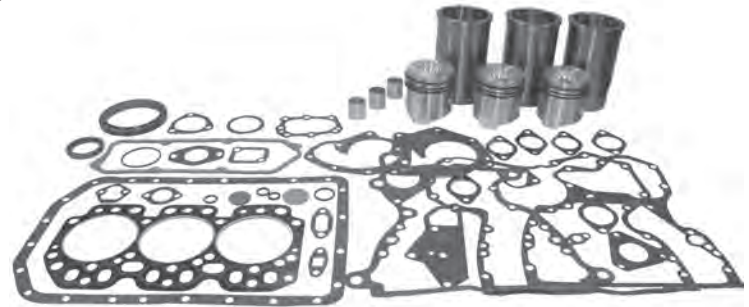

TURBOCHARGED

Order Individual Parts Below

RE33115

Piston and Sleeve Set
O-rings in Block
4.19" Bore
1.6" Pin



RE27348

Rod Bearing Std (Order 3)

RE27349

Rod Bearing .010 (Order 3)

RE27358

Rod Bearing .020 (Order 3)

RE27364

Rod Bearing .030 (Order 3)



RE27352

Main Bearing Std (Order 3)

RE27353

Main Bearing .010 (Order 3)

RE27360

Main Bearing .020 (Order 3)

RE27368

Main Bearing .030 (Order 3)



AT21139

Main Thrust Bearing Std (Order 1)

AT21132

Main Thrust Bearing .010 (Order 1)

AT21134

Main Thrust Bearing .020 (Order 1)

AT21136

Main Thrust Bearing .030 (Order 1)



RE37492

Overhaul Gasket Set



RE37489

Head Gasket Set

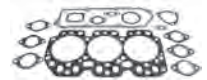

R97341

Oil Pan Gasket



AR67942

Front Crankshaft Seal



RE24959

Rear Crankshaft Seal



R57451

Piston Pin Bushing



R80033

Conn Rod Bolt



R83071

Intake Valve

R79624

Exhaust Valve



RE35685

Oil Pump





ENGINE, OVERHAUL KITS

John Deere

**JD 5200, 5300, 5400 3029
3 Cylinder Diesel Engine**

EOKJD3029A

Engine Overhaul Kit

Contains Sleeves, Pistons, Rings, Sleeve Seals,
Piston Pin Bushings, Complete Gasket Set,
Front and Rear Crankshaft Seals

(Order Bearings Separately)

O-rings in Block
4.19" Bore
1.375" Pin

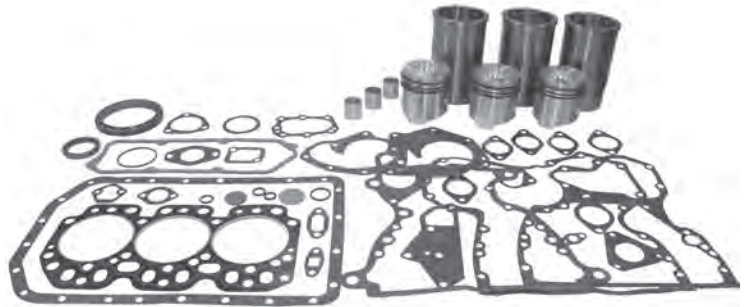

Order Individual Parts Below

RE30250

Piston and Sleeve Set
O-rings in Block
4.19" Bore
1.375" Pin



RE27348

Rod Bearing Std (Order 3)

RE27349

Rod Bearing .010 (Order 3)

RE27358

Rod Bearing .020 (Order 3)

RE27364

Rod Bearing .030 (Order 3)



RE27352

Main Bearing Std (Order 3)

RE27353

Main Bearing .010 (Order 3)

RE27360

Main Bearing .020 (Order 3)

RE27368

Main Bearing .030 (Order 3)



AT21139

Main Thrust Bearing Std (Order 1)

AT21132

Main Thrust Bearing .010 (Order 1)

AT21134

Main Thrust Bearing .020 (Order 1)

AT21136

Main Thrust Bearing .030 (Order 1)



RE37492

Overhaul Gasket Set



RE37489

Head Gasket Set

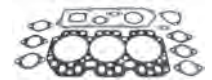

R97341

Oil Pan Gasket



AR67942

Front Crankshaft Seal



RE24959

Rear Crankshaft Seal



R55647

Piston Pin Bushing



R80033

Conn Rod Bolt



R79623

Intake Valve

R79624

Exhaust Valve



RE35685

Oil Pump





John Deere

ENGINE, OVERHAUL KITS

**JD 5400N, 5500 3.179T
3 Cylinder Diesel Engine**

EOKJD3029B

Engine Overhaul Kit

Contains Sleeves, Pistons, Rings, Sleeve Seals,
Piston Pin Bushings, Complete Gasket Set,
Front and Rear Crankshaft Seals

(Order Bearings Separately)

O-rings in Block
4.19" Bore
1.6" Pin



Order Individual Parts Below

TURBOCHARGED

RE33115

Piston and Sleeve Set
O-rings in Block
4.19" Bore
1.6" Pin



RE27348

Rod Bearing Std (Order 3)

RE27349

Rod Bearing .010 (Order 3)

RE27358

Rod Bearing .020 (Order 3)

RE27364

Rod Bearing .030 (Order 3)



RE27352

Main Bearing Std (Order 3)

RE27353

Main Bearing .010 (Order 3)

RE27360

Main Bearing .020 (Order 3)

RE27368

Main Bearing .030 (Order 3)



AT21139

Main Thrust Bearing Std (Order 1)

AT21132

Main Thrust Bearing .010 (Order 1)

AT21134

Main Thrust Bearing .020 (Order 1)

AT21136

Main Thrust Bearing .030 (Order 1)



RE37492

Overhaul Gasket Set



RE37489

Head Gasket Set

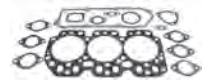

R97341

Oil Pan Gasket



AR67942

Front Crankshaft Seal



RE24959

Rear Crankshaft Seal



R57451

Piston Pin Bushing



R80033

Conn Rod Bolt



R83071

Intake Valve

R79624

Exhaust Valve



RE35685

Oil Pump





ENGINE, OVERHAUL KITS

John Deere

**JD 2020, 2510, 400, 440, 450, 480
4.202 4 Cylinder Diesel Engine**

EOKJD4202A

Engine Overhaul Kit
Contains Sleeves, Pistons, Rings, Sleeve Seals,
Piston Pin Bushings, Complete Gasket Set,
Front and Rear Crankshaft Seals

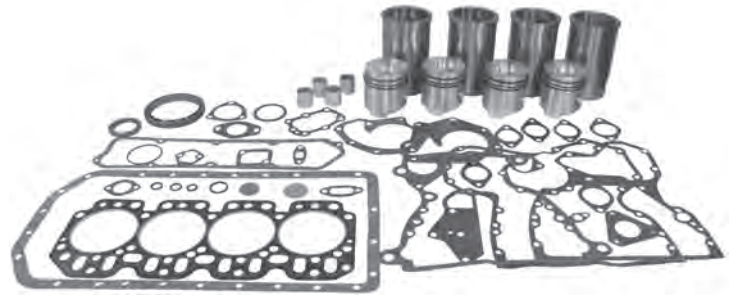

(Order Bearings Separately)

O-rings on Liner
3.86" Bore
1.185" Pin

Order Individual Parts Below

PLK481

Piston and Sleeve Set
O-rings on Liner
3.86" Bore
1.185" Pin



RE27348

Rod Bearing Std (Order 4)

RE27349

Rod Bearing .010 (Order 4)

RE27358

Rod Bearing .020 (Order 4)

RE27364

Rod Bearing .030 (Order 4)



RE27352

Main Bearing Std (Order 4)

RE27353

Main Bearing .010 (Order 4)

RE27360

Main Bearing .020 (Order 4)

RE27368

Main Bearing .030 (Order 4)



AT21139

Main Thrust Bearing Std (Order 1)

AT21132

Main Thrust Bearing .010 (Order 1)

AT21134

Main Thrust Bearing .020 (Order 1)

AT21136

Main Thrust Bearing .030 (Order 1)



RE38558

Overhaul Gasket Set



RE38847

Head Gasket Set

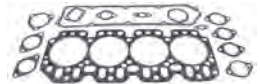

R97342

Oil Pan Gasket



AR67942

Front Crankshaft Seal



RE24959

Rear Crankshaft Seal Early-Late



T23471

Piston Pin Bushing



R74194

Conn Rod Bolt



R79623

Intake Valve

R79624

Exhaust Valve



R57160

Balancer Shaft Bushing



RE35685

Oil Pump





John Deere

ENGINE, OVERHAUL KITS

**JD 2020, 2120, 2510, 400, 440, 480
4.202 4 Cylinder Diesel Engine**

EOKJD4202B

Engine Overhaul Kit
Contains Sleeve, Pistons, Rings, Sleeve Seals,
Piston Pin Bushings, Complete Gasket Set,
Front and Rear Crankshaft Seals

(Order Bearings Separately)

O-rings in Block
3.86" Bore
1.185" Pin

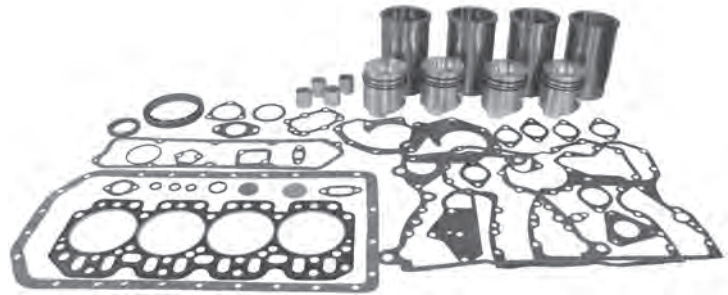

Order Individual Parts Below

AR71591

Piston and Sleeve Set
O-rings in Block
3.86" Bore
1.185" Pin



RE27348

Rod Bearing Std (Order 4)

RE27349

Rod Bearing .010 (Order 4)

RE27358

Rod Bearing .020 (Order 4)

RE27364

Rod Bearing .030 (Order 4)



RE27352

Main Bearing Std (Order 4)

RE27353

Main Bearing .010 (Order 4)

RE27360

Main Bearing .020 (Order 4)

RE27368

Main Bearing .030 (Order 4)



AT21139

Main Thrust Bearing Std (Order 1)

AT21132

Main Thrust Bearing .010 (Order 1)

AT21134

Main Thrust Bearing .020 (Order 1)

AT21136

Main Thrust Bearing .030 (Order 1)



RE38857

Overhaul Gasket Set



RE38851

Head Gasket Set

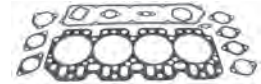

R97342

Oil Pan Gasket



AR67942

Front Crankshaft Seal



RE24959

Rear Crankshaft Seal



T23471

Piston Pin Bushing



R74194

Conn Rod Bolt



R79623

Intake Valve

R79624

Exhaust Valve



R57160

Balancer Shaft Bushing



RE35685

Oil Pump





ENGINE, OVERHAUL KITS

John Deere

JD 2520, 440A
4.219 4 Cylinder Diesel Engine

EOKJD4219A

Engine Overhaul Kit

Contains Sleeve, Pistons, Rings, Sleeve Seals, Piston Pin Bushings, Complete Gasket Set, Front and Rear Crankshaft Seals

(Order Bearings Separately)

O-rings on Liner
4.02" Bore
1.185" Pin

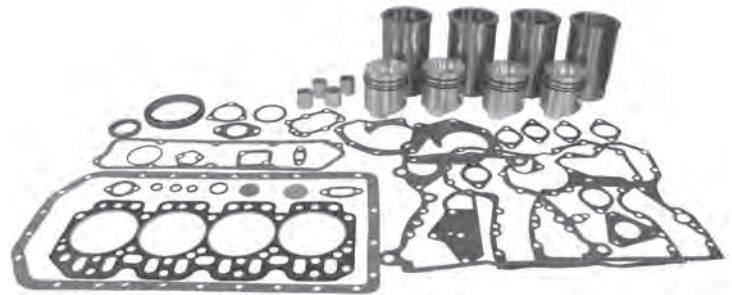

Order Individual Parts Below

PLK310

Piston and Sleeve Set
O-rings on Liner
4.02" Bore
1.185" Pin



RE27348

Rod Bearing Std (Order 4)

RE27349

Rod Bearing .010 (Order 4)

RE27358

Rod Bearing .020 (Order 4)

RE27364

Rod Bearing .030 (Order 4)



RE27352

Main Bearing Std (Order 4)

RE27353

Main Bearing .010 (Order 4)

RE27360

Main Bearing .020 (Order 4)

RE27368

Main Bearing .030 (Order 4)



AT21139

Main Thrust Bearing Std (Order 1)

AT21132

Main Thrust Bearing .010 (Order 1)

AT21134

Main Thrust Bearing .020 (Order 1)

AT21136

Main Thrust Bearing .030 (Order 1)



RE38857

Overhaul Gasket Set



RE38851

Head Gasket Set

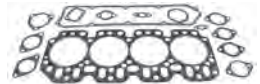

R97342

Oil Pan Gasket



AR67942

Front Crankshaft Seal



RE24959

Rear Crankshaft Seal



T23471

Piston Pin Bushing



R74194

Conn Rod Bolt



R79623

Intake Valve

R79624

Exhaust Valve



R57160

Balancer Shaft Bushing



RE35685

Oil Pump





John Deere

ENGINE, OVERHAUL KITS

**JD 2030, 2120, 401A, 480A, 450B, 401, 440, 440B, 450B
4.219 4 Cylinder Diesel Engine**

EOKJD4219B

Engine Overhaul Kit
Contains Sleeve, Pistons, Rings, Sleeve Seals,
Piston Pin Bushings, Complete Gasket Set,
Front and Rear Crankshaft Seals

(Order Bearings Separately)

O-rings in Block
4.02" Bore
1.185" Pin

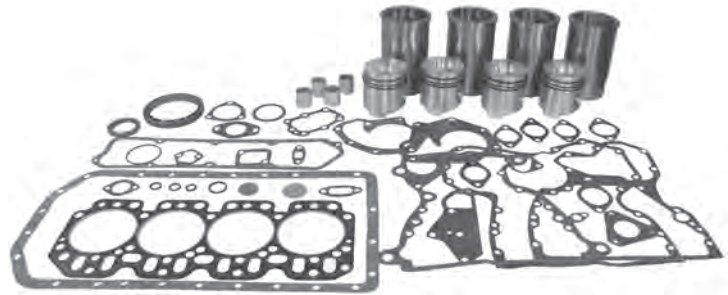

Order Individual Parts Below

AR71593

Piston and Sleeve Set
O-rings in Block
4.02" Bore
1.185" Pin



RE27348

Rod Bearing Std (Order 4)

RE27349

Rod Bearing .010 (Order 4)

RE27358

Rod Bearing .020 (Order 4)

RE27364

Rod Bearing .030 (Order 4)



RE27352

Main Bearing Std (Order 4)

RE27353

Main Bearing .010 (Order 4)

RE27360

Main Bearing .020 (Order 4)

RE27368

Main Bearing .030 (Order 4)



AT21139

Main Thrust Bearing Std (Order 1)

AT21132

Main Thrust Bearing .010 (Order 1)

AT21134

Main Thrust Bearing .020 (Order 1)

AT21136

Main Thrust Bearing .030 (Order 1)



RE38857

Overhaul Gasket Set



RE38851

Head Gasket Set

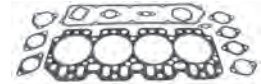

R97342

Oil Pan Gasket



AR67942

Front Crankshaft Seal



RE24959

Rear Crankshaft Seal



T23471

Piston Pin Bushing



R74194

Conn Rod Bolt



R79623

Intake Valve

R79624

Exhaust Valve



R57160

Balancer Shaft Bushing



RE35685

Oil Pump





ENGINE, OVERHAUL KITS

John Deere

**JD 2020, 2120, 2030, 2130, 310B, 401B, 410B, 450C/D, 480B/C
4.219 4 Cylinder Diesel Engine**

EOKJD4219C

Engine Overhaul Kit

Contains Sleeve, Pistons, Rings, Sleeve Seals,
Piston Pin Bushings, Complete Gasket Set,
Front and Rear Crankshaft Seals

(Order Bearings Separately)

O-rings in Block
4.02" Bore
1.375" Pin

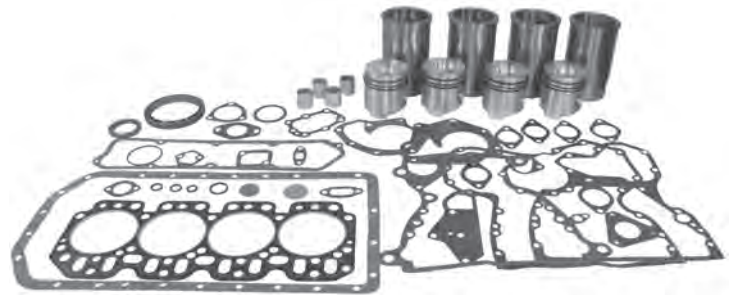

Order Individual Parts Below

AR78041

Piston and Sleeve Set
O-rings in Block
4.02" Bore
1.375" Pin



RE27348

Rod Bearing Std (Order 4)

RE27349

Rod Bearing .010 (Order 4)

RE27358

Rod Bearing .020 (Order 4)

RE27364

Rod Bearing .030 (Order 4)



RE27352

Main Bearing Std (Order 4)

RE27353

Main Bearing .010 (Order 4)

RE27360

Main Bearing .020 (Order 4)

RE27368

Main Bearing .030 (Order 4)



AT21139

Main Thrust Bearing Std (Order 1)

AT21132

Main Thrust Bearing .010 (Order 1)

AT21134

Main Thrust Bearing .020 (Order 1)

AT21136

Main Thrust Bearing .030 (Order 1)



RE38857

Overhaul Gasket Set



RE38851

Head Gasket Set

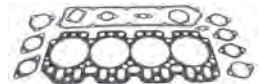

R97342

Oil Pan Gasket



AR67942

Front Crankshaft Seal



RE24959

Rear Crankshaft Seal



R55647

Piston Pin Bushing



R74194

Conn Rod Bolt



R79623

Intake Valve

R79624

Exhaust Valve



R57160

Balancer Shaft Bushing



RE35685

Oil Pump





John Deere

ENGINE, OVERHAUL KITS

**JD 2130, 2140, 2350, 2550, 2355, 2555, 210C, 310C/D, 315C, 400G
4.239 4 Cylinder Diesel Engine**

EOKJD4239A

Engine Overhaul Kit

Contains Sleeve, Pistons, Rings, Sleeve Seals,
Piston Pin Bushings, Complete Gasket Set,
Front and Rear Crankshaft Seals

(Order Bearings Separately)

O-rings in Block
4.19" Bore
1.375" Pin

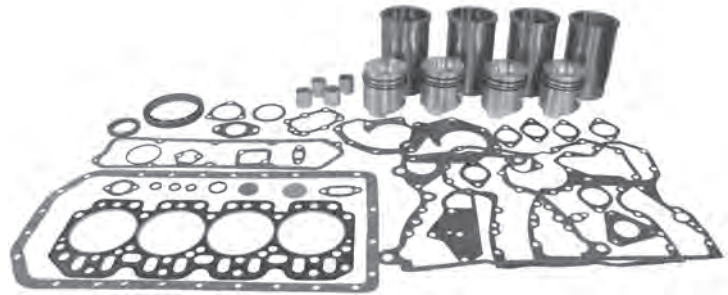

Order Individual Parts Below

RE30250

Piston and Sleeve Set
O-rings in Block
4.19" Bore
1.375" Pin



RE27348

Rod Bearing Std (Order 4)

RE27349

Rod Bearing .010 (Order 4)

RE27358

Rod Bearing .020 (Order 4)

RE27364

Rod Bearing .030 (Order 4)



RE27352

Main Bearing Std (Order 4)

RE27353

Main Bearing .010 (Order 4)

RE27360

Main Bearing .020 (Order 4)

RE27368

Main Bearing .030 (Order 4)



AT21139

Main Thrust Bearing Std (Order 1)

AT21132

Main Thrust Bearing .010 (Order 1)

AT21134

Main Thrust Bearing .020 (Order 1)

AT21136

Main Thrust Bearing .030 (Order 1)



RE38857

Overhaul Gasket Set



RE38851

Head Gasket Set

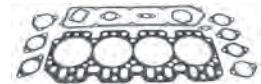

R97342

Oil Pan Gasket



AR67942

Front Crankshaft Seal



RE24959

Rear Crankshaft Seal



R55647

Piston Pin Bushing



R80033

Conn Rod Bolt



R79623

Intake Valve

R79624

Exhaust Valve



R57160

Balancer Shaft Bushing



RE35685

Oil Pump





ENGINE, OVERHAUL KITS

John Deere

JD 2140, 2650, 2750, 2555, 2755, 2850, 2855, 310C/D, 315C/D
4.239T 4 Cylinder Diesel Engine

EOKJD4239B

Engine Overhaul Kit

Contains Sleeve, Pistons, Rings, Sleeve Seals,
Piston Pin Bushings, Complete Gasket Set,
Front and Rear Crankshaft Seals

(Order Bearings Separately)

O-rings in Block
4.19" Bore
1.625" Pin

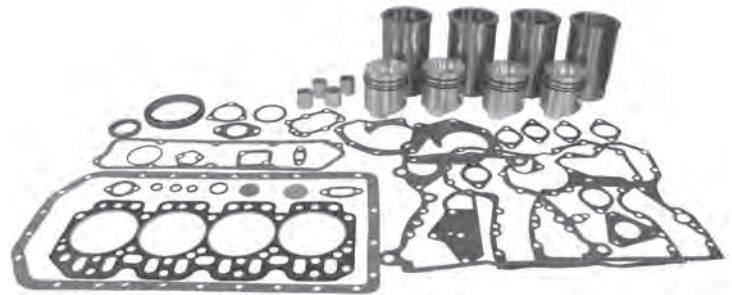

TURBOCHARGED

Order Individual Parts Below

RE33115

Piston and Sleeve Set
O-rings in Block
4.19" Bore
1.625" Pin



RE27348

Rod Bearing Std (Order 4)

RE27349

Rod Bearing .010 (Order 4)

RE27358

Rod Bearing .020 (Order 4)

RE27364

Rod Bearing .030 (Order 4)



RE27352

Main Bearing Std (Order 4)

RE27353

Main Bearing .010 (Order 4)

RE27360

Main Bearing .020 (Order 4)

RE27368

Main Bearing .030 (Order 4)



AT21139

Main Thrust Bearing Std (Order 1)

AT21132

Main Thrust Bearing .010 (Order 1)

AT21134

Main Thrust Bearing .020 (Order 1)

AT21136

Main Thrust Bearing .030 (Order 1)



RE38857

Overhaul Gasket Set



RE38851

Head Gasket Set

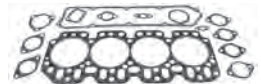

R97342

Oil Pan Gasket



AR67942

Front Crankshaft Seal



RE24959

Rear Crankshaft Seal



R57451

Piston Pin Bushing



R80033

Conn Rod Bolt



R83071

Intake Valve

R79624

Exhaust Valve



R57160

Balancer Shaft Bushing



RE35685

Oil Pump





John Deere

ENGINE, OVERHAUL KITS

**JD 210D, 290D, 310C/D, 315C/D, 400G, 482C
4039 4 Cylinder Diesel Engine**

EOKJD4039A

Engine Overhaul Kit

Contains Sleeve, Pistons, Rings, Sleeve Seals,
Piston Pin Bushings, Complete Gasket Set,
Front and Rear Crankshaft Seals

(Order Bearings Separately)

O-rings in Block
4.19" Bore
1.375" Pin

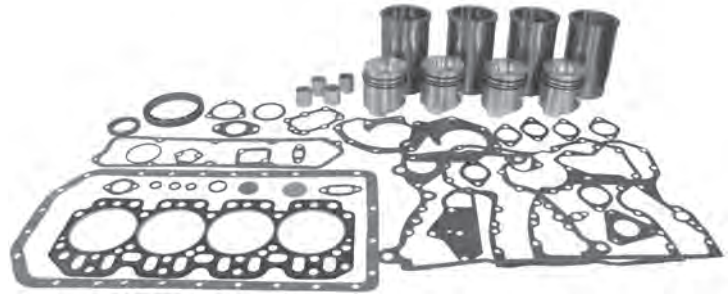

Order Individual Parts Below

RE30250

Piston and Sleeve Set
O-rings in Block
4.19" Bore
1.375" Pin



RE27348

Rod Bearing Std (Order 4)

RE27349

Rod Bearing .010 (Order 4)

RE27358

Rod Bearing .020 (Order 4)

RE27364

Rod Bearing .030 (Order 4)



RE27352

Main Bearing Std (Order 4)

RE27353

Main Bearing .010 (Order 4)

RE27360

Main Bearing .020 (Order 4)

RE27368

Main Bearing .030 (Order 4)



AT21139

Main Thrust Bearing Std (Order 1)

AT21132

Main Thrust Bearing .010 (Order 1)

AT21134

Main Thrust Bearing .020 (Order 1)

AT21136

Main Thrust Bearing .030 (Order 1)



RE38857

Overhaul Gasket Set



RE38851

Head Gasket Set

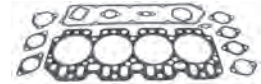

R97342

Oil Pan Gasket



AR67942

Front Crankshaft Seal



RE24959

Rear Crankshaft Seal



R55647

Piston Pin Bushing



R80033

Conn Rod Bolt



R98062

Intake Valve

R90692

Exhaust Valve



R57160

Balancer Shaft Bushing



RE35685

Oil Pump





ENGINE, OVERHAUL KITS

John Deere

JD 2140, 2650, 2750, 2850, 2555, 2755, 2855
4039T 4 Cylinder Diesel Engine

EOKJD4039B

Engine Overhaul Kit
Contains Sleeve, Pistons, Rings, Sleeve Seals,
Piston Pin Bushings, Complete Gasket Set,
Front and Rear Crankshaft Seals

(Order Bearings Separately)

O-rings in Block
4.19" Bore
1.625" Pin
Block Numbers R80032, R58979, R113612

Order Individual Parts Below

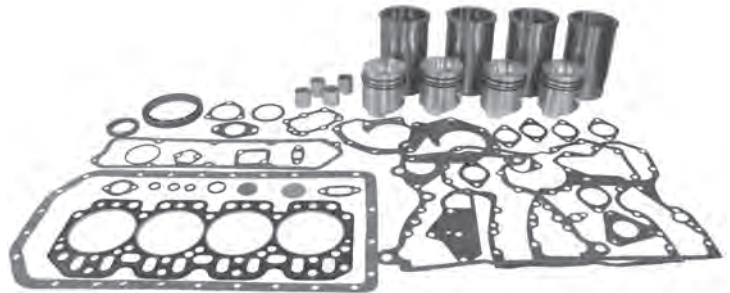

TURBOCHARGED

RE33115

Piston and Sleeve Set
O-rings in Block
4.19" Bore
1.625" Pin



RE27348

Rod Bearing Std (Order 4)

RE27349

Rod Bearing .010 (Order 4)

RE27358

Rod Bearing .020 (Order 4)

RE27364

Rod Bearing .030 (Order 4)



RE27352

Main Bearing Std (Order 4)

RE27353

Main Bearing .010 (Order 4)

RE27360

Main Bearing .020 (Order 4)

RE27368

Main Bearing .030 (Order 4)



AT21139

Main Thrust Bearing Std (Order 1)

AT21132

Main Thrust Bearing .010 (Order 1)

AT21134

Main Thrust Bearing .020 (Order 1)

AT21136

Main Thrust Bearing .030 (Order 1)



RE38857

Overhaul Gasket Set



RE38851

Head Gasket Set

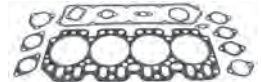

R97342

Oil Pan Gasket



AR67942

Front Crankshaft Seal



RE24959

Rear Crankshaft Seal



R57451

Piston Pin Bushing



R80033

Conn Rod Bolt



R98062

Intake Valve

R90692

Exhaust Valve



R57160

Balancer Shaft Bushing



RE35685

Oil Pump





John Deere

ENGINE, OVERHAUL KITS

**JD 2630, 2640, 410C
4.276 4 Cylinder Diesel Engine**

EOKJD4276A

Engine Overhaul Kit
Contains Sleeve, Pistons, Rings, Sleeve Seals,
Piston Pin Bushings, Complete Gasket Set,
Front and Rear Crankshaft Seals

(Order Bearings Separately)

O-rings in Block
4.19" Bore
1.375" Pin

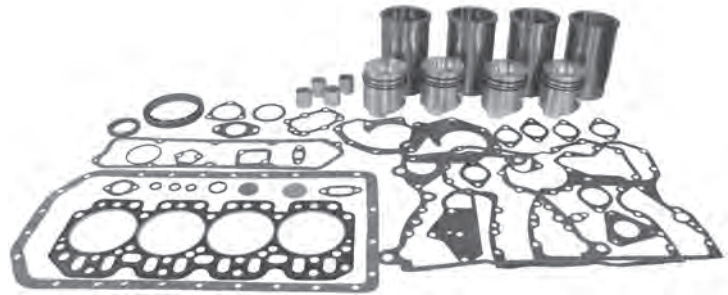

Order Individual Parts Below

RE19831

Piston and Sleeve Set
O-rings in Block
4.19" Bore
1.375" Pin



AR97517

Rod Bearing Std (Order 4)

AR97653

Rod Bearing .010 (Order 4)

AR97654

Rod Bearing .020 (Order 4)

AR97655

Rod Bearing .030 (Order 4)



RE27352

Main Bearing Std (Order 4)

RE27353

Main Bearing .010 (Order 4)

RE27360

Main Bearing .020 (Order 4)

RE27368

Main Bearing .030 (Order 4)



AT21139

Main Thrust Bearing Std (Order 1)

AT21132

Main Thrust Bearing .010 (Order 1)

AT21134

Main Thrust Bearing .020 (Order 1)

AT21136

Main Thrust Bearing .030 (Order 1)



RE38857

Overhaul Gasket Set



RE38851

Head Gasket Set

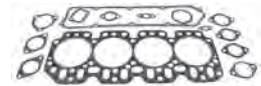

R97342

Oil Pan Gasket



AR67942

Front Crankshaft Seal



RE24959

Rear Crankshaft Seal



R55647

Piston Pin Bushing



R74194

Conn Rod Bolt



R79623

Intake Valve



R79624

Exhaust Valve



R57160

Balancer Shaft Bushing



AR79465

Oil Pump



ENGINE, OVERHAUL KITS

John Deere

JD 340D, 344E, 440C, 450E/G, 455E, 490D, 510B, 410C/D
4.276 4 Cylinder Diesel Engine

EOKJD4276B

Engine Overhaul Kit

Contains Sleeve, Pistons, Rings, Sleeve Seals, Piston Pin Bushings, Complete Gasket Set, Front and Rear Crankshaft Seals

(Order Bearings Separately)

O-rings in Block
 4.19" Bore
 1.625" Pin

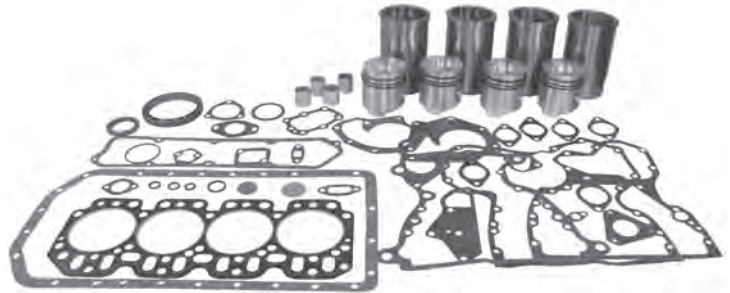

Order Individual Parts Below

RE28966

Piston and Sleeve Set
 O-rings in Block
 4.19" Bore
 1.625" Pin



AR97517

Rod Bearing STD (Order 4)

AR97653

Rod Bearing .010 (Order 4)

AR97654

Rod Bearing .020 (Order 4)

AR97655

Rod Bearing .030 (Order 4)



RE27352

Main Bearing STD (Order 4)

RE27353

Main Bearing .010 (Order 4)

RE27360

Main Bearing .020 (Order 4)

RE27368

Main Bearing .030 (Order 4)



AT21139

Main Thrust Bearing STD (Order 1)

AT21132

Main Thrust Bearing .010 (Order 1)

AT21134

Main Thrust Bearing .020 (Order 1)

AT21136

Main Thrust Bearing .030 (Order 1)



RE38857

Overhaul Gasket Set



RE38851

Head Gasket Set

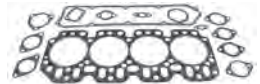

R97342

Oil Pan Gasket



AR67942

Front Crankshaft Seal



RE24959

Rear Crankshaft Seal



R57451

Piston Pin Bushing



R74195

Conn Rod Bolt



R79623

Intake Valve



R79624

Exhaust Valve



R57160

Balancer Shaft Bushing



AR79465

Oil Pump



Call Us: 1 (800) 462-7335

John Deere

ENGINE, OVERHAUL KITS

**JD 340D, 344G, 410C/D, 450E/G, 455E/G, 490E, 510C, 540D, 550A/B, 555A/B/G
4.276T 4 Cylinder Diesel Engine**

EOKJD4276C

Engine Overhaul Kit

Contains Sleeve, Pistons, Rings, Sleeve Seals,
Piston Pin Bushings, Complete Gasket Set,
Front and Rear Crankshaft Seals

(Order Bearings Separately)

O-rings in Block
4.19" Bore
1.625" Pin

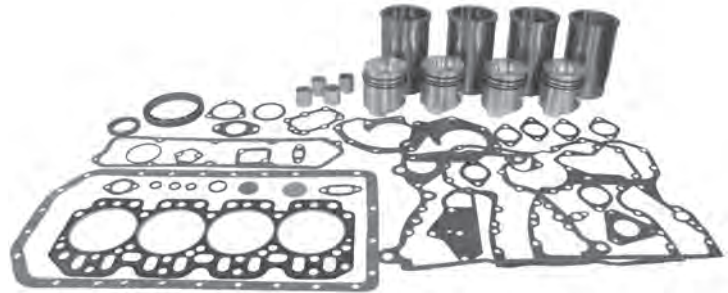

TURBOCHARGED

Order Individual Parts Below

RE53073

Piston and Sleeve Set
O-rings in Block
4.19" Bore
1.625" Pin



AR97517

Rod Bearing STD (Order 4)

AR97653

Rod Bearing .010 (Order 4)

AR97654

Rod Bearing .020 (Order 4)

AR97655

Rod Bearing .030 (Order 4)



RE27352

Main Bearing STD (Order 4)

RE27353

Main Bearing .010 (Order 4)

RE27360

Main Bearing .020 (Order 4)

RE27368

Main Bearing .030 (Order 4)



AT21139

Main Thrust Bearing STD (Order 1)

AT21132

Main Thrust Bearing .010 (Order 1)

AT21134

Main Thrust Bearing .020 (Order 1)

AT21136

Main Thrust Bearing .030 (Order 1)



RE38857

Overhaul Gasket Set



RE38851

Head Gasket Set

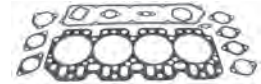

R97342

Oil Pan Gasket



AR67942

Front Crankshaft Seal



RE24959

Rear Crankshaft Seal



R57451

Piston Pin Bushing



R74195

Conn Rod Bolt



R83071

Intake Valve

R79624

Exhaust Valve



R57160

Balancer Shaft Bushing



AR79465

Oil Pump





ENGINE, OVERHAUL KITS

John Deere

JD 340D, 344E, 410C/D, 440C, 450G/E, 455E, 490D, 510B
4045 4 Cylinder Diesel Engine

EOKJD4045A

Engine Overhaul Kit

Contains Sleeve, Pistons, Rings, Sleeve Seals, Piston Pin Bushings, Complete Gasket Set, Front and Rear Crankshaft Seals

(Order Bearings Separately)

O-rings in Block
4.19" Bore
1.625" Pin

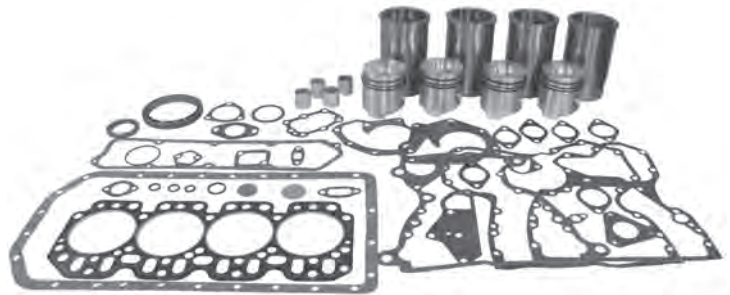

Order Individual Parts Below

RE28966

Piston and Sleeve Set
O-rings in Block
4.19" Bore
1.625" Pin



AR97517

Rod Bearing STD (Order 4)

AR97653

Rod Bearing .010 (Order 4)

AR97654

Rod Bearing .020 (Order 4)

AR97655

Rod Bearing .030 (Order 4)



RE27352

Main Bearing STD (Order 4)

RE27353

Main Bearing .010 (Order 4)

RE27360

Main Bearing .020 (Order 4)

RE27368

Main Bearing .030 (Order 4)



AT21139

Main Thrust Bearing STD (Order 1)

AT21132

Main Thrust Bearing .010 (Order 1)

AT21134

Main Thrust Bearing .020 (Order 1)

AT21136

Main Thrust Bearing .030 (Order 1)



RE38857

Overhaul Gasket Set



RE38851

Head Gasket Set

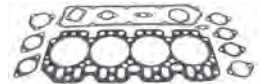

R97342

Oil Pan Gasket



AR67942

Front Crankshaft Seal



RE24959

Rear Crankshaft Seal



R57451

Piston Pin Bushing



R74195

Conn Rod Bolt



R98062

Intake Valve



R90692

Exhaust Valve



R57160

Balancer Shaft Bushing



AR79465

Oil Pump



Call Us: 1 (800) 462-7335

John Deere

ENGINE, OVERHAUL KITS

**JD 6400, 6500, 6510, 6700, 340D, 344G, 410C/D, 440C, 450G/E, 455E, 490D, 510B
4045T 4 Cylinder Diesel Engine**

EOKJD4045B

Engine Overhaul Kit
Contains Sleeve, Pistons, Rings, Sleeve Seals,
Piston Pin Bushings, Complete Gasket Set,
Front and Rear Crankshaft Seals

(Order Bearings Separately)

O-rings in Block
4.19" Bore
1.625" Pin

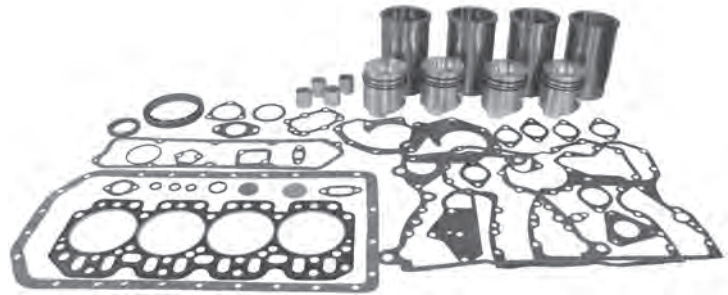

TURBOCHARGED

Order Individual Parts Below

RE53073

Piston and Sleeve Set
O-rings in Block
4.19" Bore
1.625" Pin



AR97517

Rod Bearing STD (Order 4)

AR97653

Rod Bearing .010 (Order 4)

AR97654

Rod Bearing .020 (Order 4)

AR97655

Rod Bearing .030 (Order 4)



RE27352

Main Bearing STD (Order 4)

RE27353

Main Bearing .010 (Order 4)

RE27360

Main Bearing .020 (Order 4)

RE27368

Main Bearing .030 (Order 4)



AT21139

Main Thrust Bearing STD (Order 1)

AT21132

Main Thrust Bearing .010 (Order 1)

AT21134

Main Thrust Bearing .020 (Order 1)

AT21136

Main Thrust Bearing .030 (Order 1)



RE38857

Overhaul Gasket Set



RE38851

Head Gasket Set

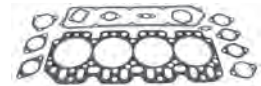

R97342

Oil Pan Gasket



AR67942

Front Crankshaft Seal



RE24959

Rear Crankshaft Seal



R57451

Piston Pin Bushing



R74195

Conn Rod Bolt



R98062

Intake Valve

R90692

Exhaust Valve



R57160

Balancer Shaft Bushing



AR79465

Oil Pump





ENGINE, OVERHAUL KITS

John Deere

JD 544
6.303 6 Cylinder Diesel Engine

EOKJD6303A

Engine Overhaul Kit
Contains Sleeve, Pistons, Rings, Sleeve Seals,
Piston Pin Bushings, Complete Gasket Set,
Front and Rear Crankshaft Seals

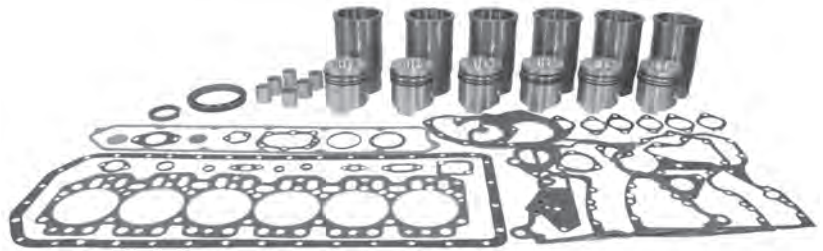

(Order Bearings Separately)

O-rings on Liner
3.86" Bore
1.185" Pin
Block Numbers T24967, T24968

Order Individual Parts Below

PLK481

Piston and Sleeve Set
O-rings on Liner
3.86" Bore
1.185" Pin



RE27348

Rod Bearing STD (Order 6)

RE27349

Rod Bearing .010 (Order 6)

RE27358

Rod Bearing .020 (Order 6)

RE27364

Rod Bearing .030 (Order 6)



RE27352

Main Bearing STD (Order 6)

RE27353

Main Bearing .010 (Order 6)

RE27360

Main Bearing .020 (Order 6)

RE27368

Main Bearing .030 (Order 6)



AT21139

Main Thrust Bearing STD (Order 1)

AT21132

Main Thrust Bearing .010 (Order 1)

AT21134

Main Thrust Bearing .020 (Order 1)

AT21136

Main Thrust Bearing .030 (Order 1)



RE38568

Overhaul Gasket Set



RE38571

Head Gasket Set

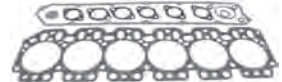

R97344

Oil Pan Gasket



AR67942

Front Crankshaft Seal



RE24959

Rear Crankshaft Seal

T23471

Piston Pin Bushing



R74194

Conn Rod Bolt



R79623

Intake Valve

R79624

Exhaust Valve



RE35685

Oil Pump





John Deere

ENGINE, OVERHAUL KITS

**JD 3420, 540, 544
6.303 6 Cylinder Diesel Engine**

EOKJD6303B

Engine Overhaul Kit
Contains Sleeve, Pistons, Rings, Sleeve Seals,
Piston Pin Bushings, Complete Gasket Set,
Front and Rear Crankshaft Seals

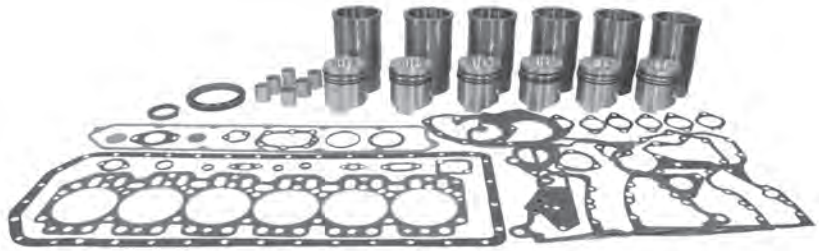

(Order Bearings Separately)

O-rings in Block
3.86" Bore
1.185" Pin
Block Numbers R53260, R55035,
R55351, R72970, R79280, T32346

Order Individual Parts Below

AR71591
Piston and Sleeve Set
O-rings in Block
3.86" Bore
1.185" Pin



RE27348
Rod Bearing STD (Order 6)

RE27349
Rod Bearing .010 (Order 6)

RE27358
Rod Bearing .020 (Order 6)

RE27364
Rod Bearing .030 (Order 6)



RE27352
Main Bearing STD (Order 6)

RE27353
Main Bearing .010 (Order 6)

RE27360
Main Bearing .020 (Order 6)

RE27368
Main Bearing .030 (Order 6)



AT21139
Main Thrust Bearing STD (Order 1)

AT21132
Main Thrust Bearing .010 (Order 1)

AT21134
Main Thrust Bearing .020 (Order 1)

AT21136
Main Thrust Bearing .030 (Order 1)



RE38568
Overhaul Gasket Set



RE38571
Head Gasket Set

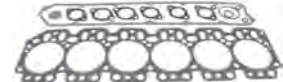

R97344
Oil Pan Gasket



AR67942
Front Crankshaft Seal



RE24959
Rear Crankshaft Seal

T23471
Piston Pin Bushing



R74194
Conn Rod Bolt



R79623
Intake Valve

R79624
Exhaust Valve



RE35685
Oil Pump





ENGINE, OVERHAUL KITS

John Deere

JD 3210, 540A
6.329 6 Cylinder Diesel Engine

EOKJD6329A

Engine Overhaul Kit
Contains Sleeve, Pistons, Rings, Sleeve Seals,
Piston Pin Bushings, Complete Gasket Set,
Front and Rear Crankshaft Seals

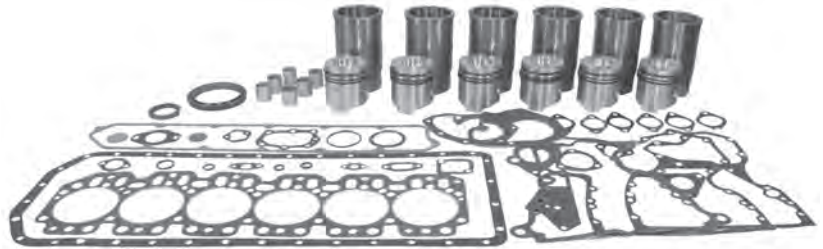

(Order Bearings Separately)

O-rings on Liner
4.02" Bore
1.185" Pin

Order Individual Parts Below

PLK310

Piston and Sleeve Set
O-rings on Liner
4.02" Bore
1.185" Pin



RE27348

Rod Bearing STD (Order 6)

RE27349

Rod Bearing .010 (Order 6)

RE27358

Rod Bearing .020 (Order 6)

RE27364

Rod Bearing .030 (Order 6)



RE27352

Main Bearing STD (Order 6)

RE27353

Main Bearing .010 (Order 6)

RE27360

Main Bearing .020 (Order 6)

RE27368

Main Bearing .030 (Order 6)



AT21139

Main Thrust Bearing STD (Order 1)

AT21132

Main Thrust Bearing .010 (Order 1)

AT21134

Main Thrust Bearing .020 (Order 1)

AT21136

Main Thrust Bearing .030 (Order 1)



RE38858

Overhaul Gasket Set



RE38852

Head Gasket Set



R97344

Oil Pan Gasket



AR67942

Front Crankshaft Seal



RE24959

Rear Crankshaft Seal



T23471

Piston Pin Bushing



R74194

Conn Rod Bolt



R79623

Intake Valve

R79624

Exhaust Valve



RE35685

Oil Pump





John Deere

ENGINE, OVERHAUL KITS

**JD 3120, 4030, 4420, 570A, 540A, 544A
6.329 6 Cylinder Diesel Engine**

EOKJD6329B

Engine Overhaul Kit

Contains Sleeve, Pistons, Rings, Sleeve Seals,
Piston Pin Bushings, Complete Gasket Set,
Front and Rear Crankshaft Seals

(Order Bearings Separately)

O-rings in Block
4.02" Bore
1.185" Pin

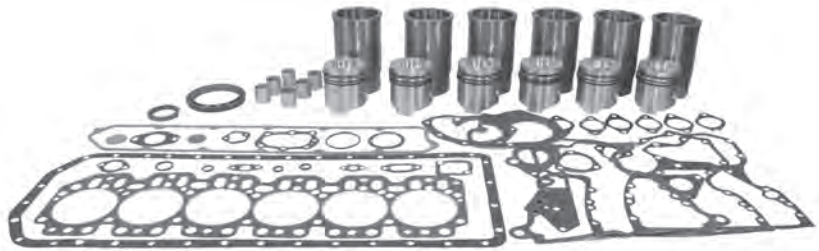

Order Individual Parts Below

AR71593

Piston and Sleeve Set
O-rings in Block
4.02" Bore
1.185" Pin



RE27348

Rod Bearing STD (Order 6)

RE27349

Rod Bearing .010 (Order 6)

RE27358

Rod Bearing .020 (Order 6)

RE27364

Rod Bearing .030 (Order 6)



RE27352

Main Bearing STD (Order 6)

RE27353

Main Bearing .010 (Order 6)

RE27360

Main Bearing .020 (Order 6)

RE27368

Main Bearing .030 (Order 6)



AT21139

Main Thrust Bearing STD (Order 1)

AT21132

Main Thrust Bearing .010 (Order 1)

AT21134

Main Thrust Bearing .020 (Order 1)

AT21136

Main Thrust Bearing .030 (Order 1)



RE38858

Overhaul Gasket Set



RE38852

Head Gasket Set

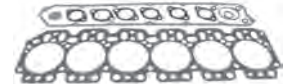

R97344

Oil Pan Gasket



AR67942

Front Crankshaft Seal



RE24959

Rear Crankshaft Seal

T23471

Piston Pin Bushing



R74194

Conn Rod Bolt



R79623

Intake Valve

R79624

Exhaust Valve



RE35685

Oil Pump





ENGINE, OVERHAUL KITS

John Deere

JD 2840, 3130, 3530, 4030, 4400, 444C/D, 570A, 710B, 444, 544A
6.329 6 Cylinder Diesel Engine

EOKJD6329C

Engine Overhaul Kit

Contains Sleeve, Pistons, Rings, Sleeve Seals, Piston Pin Bushings, Complete Gasket Set, Front and Rear Crankshaft Seals

(Order Bearings Separately)

O-rings in Block
4.02" Bore
1.375" Pin

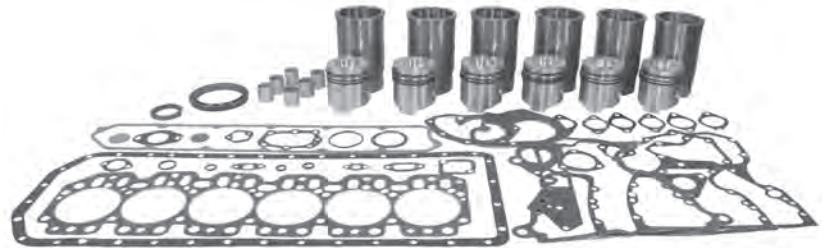

Order Individual Parts Below

AR78041

Piston and Sleeve Set
O-rings in Block
4.02" Bore
1.375" Pin



RE27348

Rod Bearing STD (Order 6)

RE27349

Rod Bearing .010 (Order 6)

RE27358

Rod Bearing .020 (Order 6)

RE27364

Rod Bearing .030 (Order 6)



RE27352

Main Bearing STD (Order 6)

RE27353

Main Bearing .010 (Order 6)

RE27360

Main Bearing .020 (Order 6)

RE27368

Main Bearing .030 (Order 6)



AT21139

Main Thrust Bearing STD (Order 1)

AT21132

Main Thrust Bearing .010 (Order 1)

AT21134

Main Thrust Bearing .020 (Order 1)

AT21136

Main Thrust Bearing .030 (Order 1)



RE38858

Overhaul Gasket Set



RE38852

Head Gasket Set

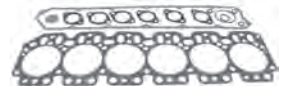

R97344

Oil Pan Gasket



AR67942

Front Crankshaft Seal



RE24959

Rear Crankshaft Seal

R55647

Piston Pin Bushing



R74194

Conn Rod Bolt



R79623

Intake Valve

R79624

Exhaust Valve



RE35685

Oil Pump





John Deere

ENGINE, OVERHAUL KITS

**JD 2940, 2950, 2955, 3040, 3050, 3140, 3150, 3155, 3255, 3350,
3640, 4420, 4530, 7440, 7445, 9900, 9910, 9920, 444D, 570B
6.359 6 Cylinder Diesel Engine**

EOKJD6359A

Engine Overhaul Kit
Contains Sleeve, Pistons, Rings, Sleeve Seals,
Piston Pin Bushings, Complete Gasket Set,
Front and Rear Crankshaft Seals

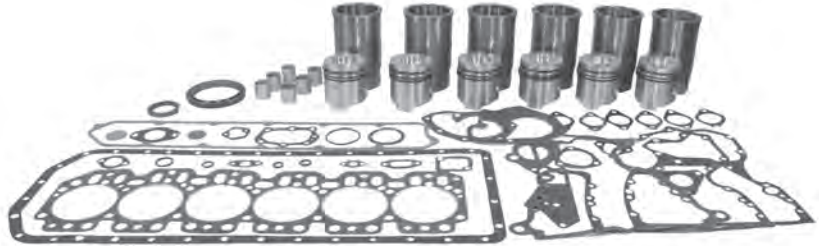

(Order Bearings Separately)

O-rings in Block
4.19" Bore
1.375" Pin

Order Individual Parts Below

RE30250

Piston and Sleeve Set
O-rings in Block
4.19" Bore
1.375" Pin



RE27348

Rod Bearing STD (Order 6)

RE27349

Rod Bearing .010 (Order 6)

RE27358

Rod Bearing .020 (Order 6)

RE27364

Rod Bearing .030 (Order 6)



RE27352

Main Bearing STD (Order 6)

RE27353

Main Bearing .010 (Order 6)

RE27360

Main Bearing .020 (Order 6)

RE27368

Main Bearing .030 (Order 6)



AT21139

Main Thrust Bearing STD (Order 1)

AT21132

Main Thrust Bearing .010 (Order 1)

AT21134

Main Thrust Bearing .020 (Order 1)

AT21136

Main Thrust Bearing .030 (Order 1)



RE38858

Overhaul Gasket Set



RE38852

Head Gasket Set

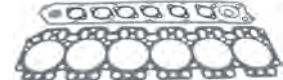

R97344

Oil Pan Gasket



AR67942

Front Crankshaft Seal



RE24959

Rear Crankshaft Seal

R55647

Piston Pin Bushing



R80033

Conn Rod Bolt



R79623

Intake Valve

R79624

Exhaust Valve



RE35685

Oil Pump





ENGINE, OVERHAUL KITS

John Deere

JD 3140, 3540, 3550, 4050, 7200, 7445, 9400, 9930, 444D, 544G/E, 570B, 710B/C
6.359T 6 Cylinder Diesel Engine

EOKJD6359B

Engine Overhaul Kit

Contains Sleeve, Pistons, Rings, Sleeve Seals, Piston Pin Bushings, Complete Gasket Set, Front and Rear Crankshaft Seals

(Order Bearings Separately)

O-rings in Block
4.19" Bore
1.625" Pin

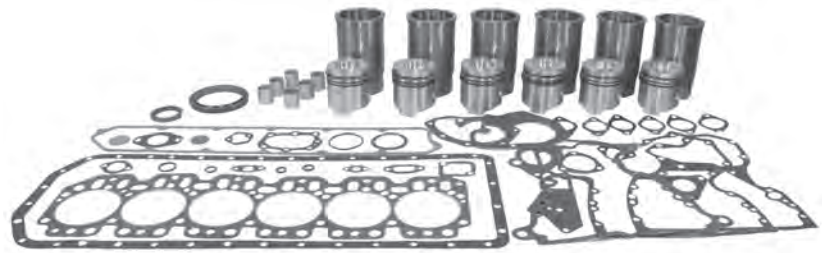

TURBOCHARGED

Order Individual Parts Below

RE33115

Piston and Sleeve Set
O-rings in Block
4.19" Bore
1.625" Pin



RE27348

Rod Bearing STD (Order 6)

RE27349

Rod Bearing .010 (Order 6)

RE27358

Rod Bearing .020 (Order 6)

RE27364

Rod Bearing .030 (Order 6)



RE27352

Main Bearing STD (Order 6)

RE27353

Main Bearing .010 (Order 6)

RE27360

Main Bearing .020 (Order 6)

RE27368

Main Bearing .030 (Order 6)



AT21139

Main Thrust Bearing STD (Order 1)

AT21132

Main Thrust Bearing .010 (Order 1)

AT21134

Main Thrust Bearing .020 (Order 1)

AT21136

Main Thrust Bearing .030 (Order 1)



RE38858

Overhaul Gasket Set



RE38852

Head Gasket Set

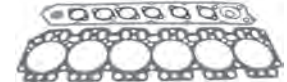

R97344

Oil Pan Gasket



AR67942

Front Crankshaft Seal



RE24959

Rear Crankshaft Seal

R57451

Piston Pin Bushing



R80033

Conn Rod Bolt



R83071

Intake Valve

R79624

Exhaust Valve



AR79465

Oil Pump





John Deere

ENGINE, OVERHAUL KITS

**JD 2955, 3155, 3255, 3640, 3650, 9900, 9910, 9920, 444D, 570B
6059 6 Cylinder Diesel Engine**

EOKJD6059A

Engine Overhaul Kit

Contains Sleeve, Pistons, Rings, Sleeve Seals,
Piston Pin Bushings, Complete Gasket Set,
Front and Rear Crankshaft Seals

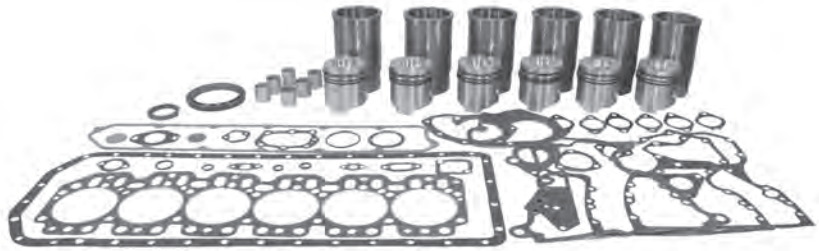

(Order Bearings Separately)

O-rings in Block
4.19" Bore
1.375" Pin

Order Individual Parts Below

RE30250

Piston and Sleeve Set
O-rings in Block
4.19" Bore
1.375" Pin



RE27348

Rod Bearing STD (Order 6)

RE27349

Rod Bearing .010 (Order 6)

RE27358

Rod Bearing .020 (Order 6)

RE27364

Rod Bearing .030 (Order 6)



RE27352

Main Bearing STD (Order 6)

RE27353

Main Bearing .010 (Order 6)

RE27360

Main Bearing .020 (Order 6)

RE27368

Main Bearing .030 (Order 6)



AT21139

Main Thrust Bearing STD (Order 1)

AT21132

Main Thrust Bearing .010 (Order 1)

AT21134

Main Thrust Bearing .020 (Order 1)

AT21136

Main Thrust Bearing .030 (Order 1)



RE38858

Overhaul Gasket Set



RE38852

Head Gasket Set

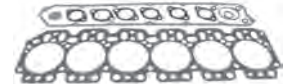

R97344

Oil Pan Gasket



AR67942

Front Crankshaft Seal



RE24959

Rear Crankshaft Seal

R55647

Piston Pin Bushing



R80033

Conn Rod Bolt



R98062

Intake Valve

R90692

Exhaust Valve



RE35685

Oil Pump





ENGINE, OVERHAUL KITS

John Deere

**JD 3140, 6506, 6600, 7200, 7445, 9400, 9930, 444D, 544G/E, 570B, 710B/C
6059T Cylinder Diesel Engine**

EOKJD6059B

Engine Overhaul Kit

Contains Sleeve, Pistons, Rings, Sleeve Seals, Piston Pin Bushings, Complete Gasket Set, Front and Rear Crankshaft Seals

(Order Bearings Separately)

O-rings in Block

4.19" Bore

1.625" Pin

Block Numbers R80032, R58979, R113612

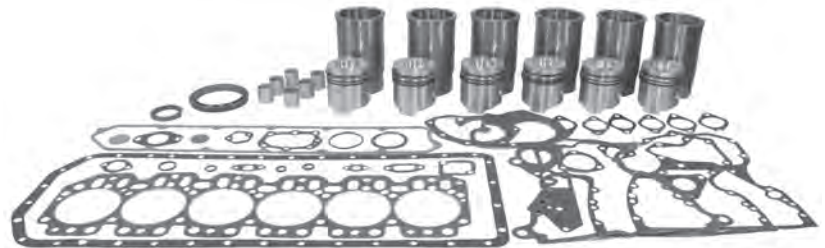

TURBOCHARGED

Order Individual Parts Below

RE33115

Piston and Sleeve Set

O-rings in Block

4.19" Bore

1.625" Pin



RE38858

Overhaul Gasket Set



RE27348

Rod Bearing STD (Order 6)

RE27349

Rod Bearing .010 (Order 6)

RE27358

Rod Bearing .020 (Order 6)

RE27364

Rod Bearing .030 (Order 6)



RE38852

Head Gasket Set

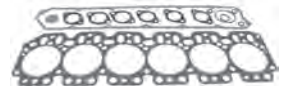

R97344

Oil Pan Gasket



AR67942

Front Crankshaft Seal



RE24959

Rear Crankshaft Seal

RE27352

Main Bearing STD (Order 6)

RE27353

Main Bearing .010 (Order 6)

RE27360

Main Bearing .020 (Order 6)

RE27368

Main Bearing .030 (Order 6)



R57451

Piston Pin Bushing



R80033

Conn Rod Bolt



AT21139

Main Thrust Bearing STD (Order 1)

AT21132

Main Thrust Bearing .010 (Order 1)

AT21134

Main Thrust Bearing .020 (Order 1)

AT21136

Main Thrust Bearing .030 (Order 1)



R98062

Intake Valve



R90692

Exhaust Valve

AR79465

Oil Pump





John Deere

ENGINE, OVERHAUL KITS

6.414 6 Cylinder Diesel Engine

EOKJD6414A

Engine Overhaul Kit

Contains Sleeve, Pistons, Rings, Sleeve Seals, Piston Pin Bushings, Complete Gasket Set, Front and Rear Crankshaft Seals

(Order Bearings Separately)

O-rings in Block
4.19" Bore
1.625" Pin

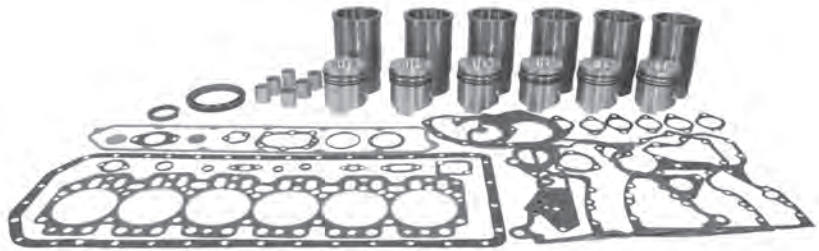

Order Individual Parts Below

RE28966

Piston and Sleeve Set
O-rings in Block
4.19" Bore
1.625" Pin



AR97517

Rod Bearing STD (Order 6)

AR97653

Rod Bearing .010 (Order 6)

AR97654

Rod Bearing .020 (Order 6)

AR97655

Rod Bearing .030 (Order 6)



RE27352

Main Bearing STD (Order 6)

RE27353

Main Bearing .010 (Order 6)

RE27360

Main Bearing .020 (Order 6)

RE27368

Main Bearing .030 (Order 6)



AT21139

Main Thrust Bearing STD (Order 1)

AT21132

Main Thrust Bearing .010 (Order 1)

AT21134

Main Thrust Bearing .020 (Order 1)

AT21136

Main Thrust Bearing .030 (Order 1)



RE38555

Overhaul Gasket Set



RE38852

Head Gasket Set

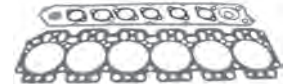

R97344

Oil Pan Gasket



AR67942

Front Crankshaft Seal



RE24959

Rear Crankshaft Seal

R57451

Piston Pin Bushing



R74195

Conn Rod Bolt



R79623

Intake Valve



R79624

Exhaust Valve

AR79465

Oil Pump





ENGINE, OVERHAUL KITS

John Deere

JD 544B/C/D, 624E, 640, 640D, 643D, 648D, 655A/B, 670A/B, 672A/B,
690D/E, 693D, 750B, 755A/B, 755, 790E
6.414 6 Cylinder Diesel Engine

EOKJD6414B

Engine Overhaul Kit
Contains Sleeve, Pistons, Rings, Sleeve Seals,
Piston Pin Bushings, Complete Gasket Set,
Front and Rear Crankshaft Seals

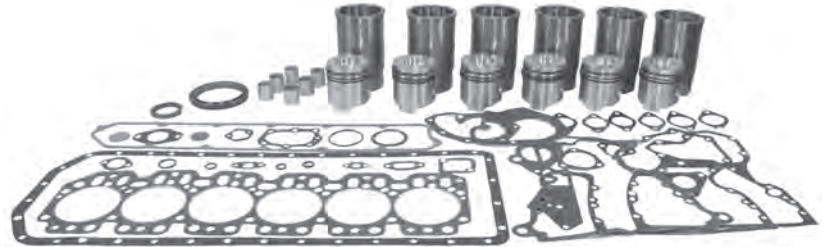

(Order Bearings Separately)

O-rings in Block
4.19" Bore
1.625" Pin

Order Individual Parts Below

TURBOCHARGED

RE53073

Piston and Sleeve Set
O-rings in Block
4.19" Bore
1.625" Pin



RE38555

Overhaul Gasket Set



AR97517

Rod Bearing STD (Order 6)

AR97653

Rod Bearing .010 (Order 6)

AR97654

Rod Bearing .020 (Order 6)

AR97655

Rod Bearing .030 (Order 6)



RE38852

Head Gasket Set



R97344

Oil Pan Gasket



AR67942

Front Crankshaft Seal



RE24959

Rear Crankshaft Seal

RE27352

Main Bearing STD (Order 6)

RE27353

Main Bearing .010 (Order 6)

RE27360

Main Bearing .020 (Order 6)

RE27368

Main Bearing .030 (Order 6)



R57451

Piston Pin Bushing



R74195

Conn Rod Bolt



AT21139

Main Thrust Bearing STD (Order 1)

AT21132

Main Thrust Bearing .010 (Order 1)

AT21134

Main Thrust Bearing .020 (Order 1)

AT21136

Main Thrust Bearing .030 (Order 1)



R83071

Intake Valve



R79624

Exhaust Valve

AR79465

Oil Pump



John Deere

ENGINE, OVERHAUL KITS

6068 6 Cylinder Diesel Engine

EOKJD6068A

Engine Overhaul Kit
 Contains Sleeve, Pistons, Rings, Sleeve Seals,
 Piston Pin Bushings, Complete Gasket Set,
 Front and Rear Crankshaft Seals

(Order Bearings Separately)

O-rings in Block
 4.19" Bore
 1.625" Pin

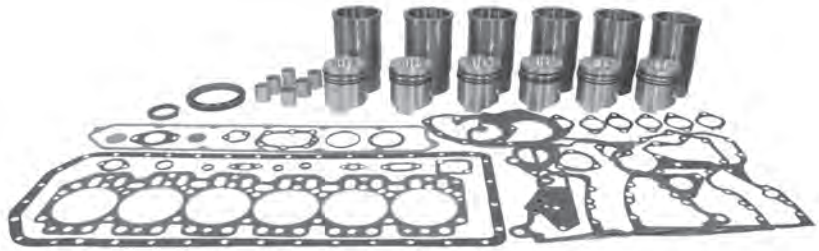

Order Individual Parts Below

RE28966

Piston and Sleeve Set
 O-rings in Block
 4.19" Bore
 1.625" Pin



AR97517

Rod Bearing STD (Order 6)

AR97653

Rod Bearing .010 (Order 6)

AR97654

Rod Bearing .020 (Order 6)

AR97655

Rod Bearing .030 (Order 6)



RE27352

Main Bearing STD (Order 6)

RE27353

Main Bearing .010 (Order 6)

RE27360

Main Bearing .020 (Order 6)

RE27368

Main Bearing .030 (Order 6)



AT21139

Main Thrust Bearing STD (Order 1)

AT21132

Main Thrust Bearing .010 (Order 1)

AT21134

Main Thrust Bearing .020 (Order 1)

AT21136

Main Thrust Bearing .030 (Order 1)



RE38555

Overhaul Gasket Set



RE38852

Head Gasket Set

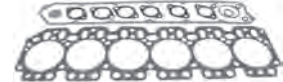

R97344

Oil Pan Gasket



AR67942

Front Crankshaft Seal



RE24959

Rear Crankshaft Seal

R57451

Piston Pin Bushing



R74195

Conn Rod Bolt



R98062

Intake Valve

R90692

Exhaust Valve



AR79465

Oil Pump





ENGINE, OVERHAUL KITS

John Deere

JD 6800, 6900, 7210, 7400, 7410, 7600, 9400, 544B/C/D, 624E, 640D, 643D, 648D/E, 653, 655A/B, 670A/B, 672A/B690D/E, 693D, 750B, 755, 755A/B, 790E
6068 6 Cylinder Diesel Engine

EOKJD6068B

Engine Overhaul Kit
Contains Sleeve, Pistons, Rings, Sleeve Seals, Piston Pin Bushings, Complete Gasket Set, Front and Rear Crankshaft Seals

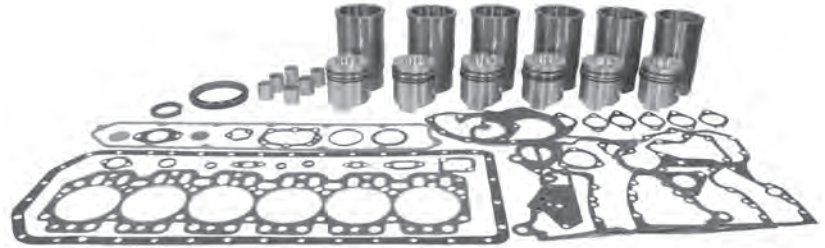

(Order Bearings Separately)

O-rings in Block
4.19" Bore
1.625" Pin

Order Individual Parts Below

TURBOCHARGED

RE53073

Piston and Sleeve Set
O-rings in Block
4.19" Bore
1.625" Pin



RE38555

Overhaul Gasket Set



AR97517

Rod Bearing STD (Order 6)

AR97653

Rod Bearing .010 (Order 6)

AR97654

Rod Bearing .020 (Order 6)

AR97655

Rod Bearing .030 (Order 6)



RE38852

Head Gasket Set



R97344

Oil Pan Gasket



AR67942

Front Crankshaft Seal



RE24959

Rear Crankshaft Seal

RE27352

Main Bearing STD (Order 6)

RE27353

Main Bearing .010 (Order 6)

RE27360

Main Bearing .020 (Order 6)

RE27368

Main Bearing .030 (Order 6)



R98062

Piston Pin Bushing



R90692

Conn Rod Bolt



AT21139

Main Thrust Bearing STD (Order 1)

AT21132

Main Thrust Bearing .010 (Order 1)

AT21134

Main Thrust Bearing .020 (Order 1)

AT21136

Main Thrust Bearing .030 (Order 1)



R79623

Intake Valve



R79624

Exhaust Valve

AR79465

Oil Pump



John Deere

ENGINE, CRANKSHAFTS

CRANKSHAFT43

Replaces **3T84, CH10676, CH20055**
Crankshaft, JD 3T90



Fits 950, 1050

CRANKSHAFT10

Replaces **RE20585, R81959**
Crankshaft, JD 4.219, 4.239, 4.039
Long Nose, 60mm/2.36



Fits 2350, 2550, 2750, 2355, 2555, 2755, 2140, 450C,
450D, 410C, 410D

CRANKSHAFT20

Replaces **T23516, AT18031**
Crankshaft, JD 3.152, 3.164, 3.179



Fits 820, 1020, 1120, 1520, 830, 930, 1530, 1630, 2040,
2240, 350, 350B, 350C, 300, 301, 300B

CRANKSHAFT30

Replaces **R54501, AR62362,
RE33845, RE57660, RE56792**
Crankshaft, JD 4.276



Fits 2630, 2640, 550, 555

CRANKSHAFT52

Replaces **R101223**
Crankshaft, JD 3.179, 3029
Long Nose, 60mm/2.36 Nose



Fits 2155, 5200, 5300, 5400, 5105, 5205

CRANKSHAFT42

Replaces **RE54883, R120009**
Crankshaft, JD 4045



Fits 6400, 6500, 410C, 510C, 610C, 410D, 510D, 450G,
455G, 550G, 555G, 650G, 490D, 344E, 595D, 590D, 495D

CRANKSHAFT07

Replaces **T23517, AT18030, RE57664, RE33197**
Crankshaft, JD 4.219, 4.239
4 Cylinder Short Nose



Fits 2020, 2030, 2440, 2120, 2130, 2140, 2510, 2520,
1640, 1840, 2040, 450, 450B, 450C, 310, 410, 410B,
410C

CRANKSHAFT46

Replaces **RE50618,
R113596, RE504638**
Crankshaft, JD 4.5 Power Tech



Fits 5410, 5510, 6110, 6310, 6410, 6405, 310E, 310SE,
315SE, 410E, 450G, 455G, 550G, 555G, 650G

ENGINE, CRANKSHAFTS & CAMSHAFTS

John Deere

CRANKSHAFT51

Replaces T23266, AT22562, R108679
Crankshaft, 6.303, 6.329



Fits 2840, 3130, 3055, 3155, 3255, 3530, 4030, 4050, Combines 4400, 4425, 960, 444, 444C, 444CH, 444D, 544A, 570A, 710B

CRANKSHAFT47

Replaces R104523, RE45541, R54619, R33687, RE502191
Crankshaft, JD 6068



Fits 7600

CRANKSHAFT54

Replaces AR96189, R104855, R63451, RE53202
Crankshaft, JD 6404, 6466, 6076



Fits 4000, 4010, 4020, 4040, 4050, 4230, 4240, 4250, 4320, 4430, 4440, 4450, 4520, 4620, 4630, 4640, 4650, 4840, 4850, 4055, 4255, 4455, 4555, 4560, 4755, 4760, 4955, 4960, 8450, 8560, 8760, 8960, 8100, 8200, 8300, 644D, 740A, 770B, 772B, 790, 792, 9500, 9600, 9960, 5440, 5460, 5720, 5730, 6600, 6620, 7020, 7700, 7720, 8430, 8440, 8820, 9940, 9950, 600, 644, 646, 690, 740A, 644C, 770A, 644E, 740E, 740G, 748E, 748G, 770BH, 772BH, 7800, 792D, 850C, 892E, 892LC, 9965, 646A, 740A, 790D, 646

AR44393

Replaces R42351
Camshaft, JD 4.270
(Check Casting Number Before Ordering)



Fits 3010, 3020, 500

R82820

Camshaft, JD 4 Cylinder
Requires R81513 Tachometer Drive Pin (NOT INCLUDED)



T20073

Lifter

Fits 4202, 4219, 4239, 4039, 4045 Engines, 1830, 2630, 2440, 2640, 2020, 2120, 2030, 2130, 2440, 3120, 3030, 2350, 2550, 2750, 2155, 2355, 2555, 2755, 2510, 2520, 400, 401, 310, 410, 410C, 510C, 610C, 550, 555, B, C, 340D, 440D, 450G, 455G, 550G, 555G



AR49142

Replaces R46427
Camshaft, JD 4.270
(Check Casting Number Before Ordering)



Fits 3010, 3020, 500

AR100385

Replaces AR79610, AR71709, AR74144, AR100384 - Marked R71529, R71530, R71531, R78316, R77259, R59420, R61150 R64086
Camshaft, JD 6.404, 6466



Fits 6.404 and 6466 Engines, 4000, 4020 S/N 215000-335845, 4240, 4240S, 4250, 4320, 4350, 4430, 4440, 4450, 4455, 4520, 4620, 4630, 4640, 4650, 4840, 4850, 7020, 8430, 8440, 8450, 850B, 8640, 8650, 600 S/N 215000-335845, 644C, 644D, 6466, 6466A, 6466D, 690B, 690C, 693B, 693C, 740A, 762, 762A, 762B S/N 233593-317858, 770A, 770B, 772A, 772B, 790, 790D, 792, 793D, 892D S/N 233593-317858, 892

R52773

Lifter



Fits 4000, 4020 (ASN 201000), 4050, 4055, 4230, 4240, 4250, 4255, 4320, 4430, 4440, 4450, 4455, 4520, 4620, 4630, 4640, 4650, 4850, 4840, 7020, 8430, 8440, 8450



R26342

Lifter

Fits 3010, 3020, 4010, 4020, 500, 600





John Deere

ENGINE, BALANCER SHAFTS & FLYWHEELS

AR61351

Replaces RE26282
Balancer Shaft, R/H



AR61352

Replaces RE26283
Balancer Shaft, L/H



Fit 2020, 2120, 2030, 2130, 2440, 2350, 2550, 2750, 2355, 2555, 2755, 2510, 2520, 310, 410

AR69710

Balancer Shaft, R/H
Bolt on Weight Style



AR69711

Balancer Shaft, L/H
Bolt on Weight Style



Fits 2630, 2640, 2355, 2555, 2755, 6400, 6500, 2040S, 2140, 401C, 510C, 610C, 550, 555, B, C, 340D, 440D, 450G, 455G, 550G, 555G

AT21381

Flywheel
For Continuous
Running PTO



Fits 2020, 2120, 1830, 2030, 2130, 300, 400, 401

AR92508

Replaces AT26482, R70490
Flywheel
For Independent PTO

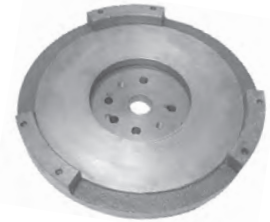

Fits 1830, 2030, 2130, 2840, 2940, 3030, 3120, 3130

T20094

Crankshaft Gear



Fits Engines 3.152, 3.164, 3.179, 4.202, 4.219, 4.239, 4.276, 4039, 4045, 6.303, 6.329, 6.359, 6059, 6068, 2.9L, 45.L, 6.8L; Tractors 820, 920, 1020, 1520, 830, 930, 1030, 1130, 1530, 1630, 1830, 2030, 2130, 2630, 2040, 2240, 2040, 2240, 2440, 2640, 2020, 2120, 2030, 2130, 2440, 3120, 3030, 3130, 2840, 2940, 2150, 2350, 2550, 2750, 2155, 2355, 2555, 2755, 300, 300B, 400, 301, 302, 401, 310, 410, 5300, 5400, 5500, 6200, 6300, 6400, 6500 And Many Others

ENGINE, CONNECTING RODS

John Deere

AR86981

Replaces AR26938,
AR59419, R26047,
R53285, SE500081
Connecting Rod
1.500" Pin Diameter



Fits 3010, 3020, 4000, 4010, 4020, 4230

RE58347

Replaces AR71076,
R113612, R121191,
R58979, R80032,
RE42733
Connecting Rod
1.625" Pin Diameter



Fits 1850, 1950, 2650, 2850, 2040S, 2140,
2155, 2355, 2555, 2755, 3255, 4050, 5500,
6200, 6300, SE6200, SE7300, 7200

RE500002

Replaces RE500000
Connecting Rod
1.375" Pin Diameter



Fits 5410, 5415, 5420, 5425, 5510, 5520,
5525, 5615, 5625, 5715, 5725, 6010,
6110, 6205, 6505, 6510, 6520, 6603,
6610, 210, 230, 310, 315, 344, 410, 450,
485, 486, 488, 550, 650, 670, 672, 700

RE19733

Replaces AT18005,
AT97102, R81410, T20007
Connecting Rod
1.187" Pin Diameter



Fits 820, 1020, 1520, 2020, 830, 1530,
2510, 2520, 2030, 300B, 310, 302, 302A,
350, 350B, 410, 450, 450B, 400, 401A,
440, 440A, 440B, 480A, 540, 570A

RE500608

Replaces R114081,
R500335, RE50770
Connecting Rod
1.625" Pin Diameter



Fits 6110, 6110D, 6110L, 6120, 6120L,
6125D, 6210, 6210L, 6215, 6220, 6220L,
6230, 6230 Premium, 6310, 6310L, 6310S, 6320,
6320L, 6330, 6330, 6405, 6410, 6410L, 6410S, 6415,
6420, 6420L, 6430, 6430 Premium, 6510L, 6510S, 6520L,
6605, 6615, 6715, 7130, 7130 Premium, 7210, 7220, 7230,
7230 Premium, 7320, 7330, 7330 Premium, 7410, 7420,
7430 Premium, 7510, 7520, 7530 Premium, 7610, 7720,
7820, 9400 (With 6068HH050 Engine S/N 701726>), 9410,
9450, 9550, 9550SH, 9560, 9560SH, 9560STS, 9570STS,
4045H, 4045T, 6068H, 6068T

RE21076

Replaces R51727, R80034,
RE16495
Connecting Rod
1.375" Pin Diameter



Fits 820, 920, 1020, 1520, 830, 930, 1030,
1130, 1530, 1630, 1830, 2030, 2130, 2630, 2040,
2240, 2640, 2020, 2120, 2030, 2130, 2440, 2150, 2155,
2355, 2555, 2755, 300, 300B, 400, 301, 302, 401, 310,
410, 70, 45, 55, 302A, 310B, 480B, 301A, 444, 570B, 302,
444C, 444CH, 444D, 544A, 210C, 310C, 310D, 315C,
315D, 401B, 401C, 401D, 410B, 415B, 482C, 515B, 710B,
290D, 490, 70D, 400G, 355D, 570A, 54, 450C, 450D,
455D, 480C, 350D, 350B, 350C, 244E, 34, 415C, 44, 210D



John Deere

ENGINE, MISC

R113752

Oil Pump Tube



Fits 4.202, 920, 1020, 1520, 830, 930, 1030, 1130, 1530, 1630, 1830, 2030, 2130, 2630, 2040, 2240, 2440, 2640, 2020, 2120, 3120, 3030, 3130, 2840, 2940, 300, 300B, 400, 301, 302, 401, 310, 410

R32428

Oil Pump Gear
20 Teeth



Fits 3010, 3020, 4010, 4020, 500, 600

R64568

Oil Pump Gear and Shaft



Fits 4320, 4230, 4430, 4630, 4040, 4440, 4640, 4840, 8430, 8440, 8450, 644D, 646A, 740A, 690B, 693C, 740, 6600, 7700

T19044

Spin On Oil Filter



Fits Most John Deere Tractors

MANIFOLDS & MUFFLERS

John Deere

T20252

Manifold
3 Cylinder
Diesel



Fits 820, 920, 1020, 1520, 830, 930, 1030, 1130, 1530, 1630, 1830, 2040, 2240, 300, 300B, 301, 302

T20249

Manifold
4 Cylinder
Diesel



Fits 2020, 2120, 2030, 2130, 2630, 2440, 2640, 2510, 2520, 400, 401, 310, 410

R26362

Diesel Exhaust Manifold



Fits 4000, 4010, 4020, 4040, 4050, 4230, 4240

T20006

Exhaust Manifold Gasket



T19978

Muffler Clamp



Fits 820, 920, 1020, 1520, 830, 930, 1030, 1130, 1530, 1630, 1830, 2630, 2040, 2240, 2440, 2640, 2020, 2120, 2030, 2130, 2440, 3120, 3030, 3130, 2840, 2940, 2150, 2350, 2550, 2750, 2155, 2355, 2555, 2755, 2510, 2520, 300, 300B, 400, 301, 302, 401, 310, 410

M408T

Manifold



Fits M, MT, 40, 420, 320, 330

AL27388

Oval Muffler



Fits 830, 1020, 1130, 1520, 1530, 1630

AL27389

Oval Muffler



Fits 1830, 2020, 2030, 2120, 2130, 2440, 2640

AL31492

Under Hood Muffler



Fits 2355, 2555, 1640, 1840, 2040

AL35753

Under Hood Muffler



Fits 2140, 2555, 2750, 2755

AL37167

Under Hood Muffler



Fits 3050, 3350, 3640, 3040, 3140



John Deere

FUEL

AR89564

Replaces AR88239, AR49877, AR73673, AR56290, AT25505, AT30290, 17574, 17579, 18457, 19762, 16422, 20500, 22042, 22202, 17427, 17511, 20631, 18742, 27333

Injector



Fits 820, 920, 1020, 1120, 1520, 2020, 2120, 3120, 830, 930, 1030, 1130, 1530, 1630, 1830, 2030, 2130, 3030, 3130, 4030, 1040, 1140, 1640, 2040, 2040S, 2440, 2840, 2940, 2150, 2350, 2550, 2950, 3150, 2155, 2355, 2555, 2955, 3055, 3155, 3255, 2510, 2520, 300, 300B, 400, 301ABC, 302ABC, 401ABCD, 310ABCD, 410ABCD, 350, 450, 350B, 450B, 350C, 450C, 355D, 450D

AR50781

Replaces AR39811, AR46846, 18767, 20494

Injector



Fits 3020 S/N 123000>, 4000, 4020 S/N 201000>, 4230 S/N <499999, 4520, 6600 and 7700 Combines, 500, 510, 500C

RE531436

Replaces RE507766

Injector



Fits 6020, 6120, 6220, 6320, 6420, 6520, 6620, 6120L, 6220L, SE6120, SE6420, SE6620, 6515, 6615, 6715

RE36939

Replaces RE38087

Injector



Fits 5400 6200, 6300, 6400, 6500, 6200L, 6300L, 6400L, 6500L, 8875 Skidsteer

RE36935

Replaces RE36936, 28480, 28481

Injector



Fits 5200, 5300, 5500, 5500N S/N <308582, 5310 S/N <108936, 5103, 5203 S/N <108882, 5130S, 5600, 6500, 6506, 3200, 3200X, 3210, 3210X, 240 Skidsteer

RE37503

Replaces RE31757, AR90023, AR90024, AR68364, AR88240, 27233, 27336, 26993, 26992

Injector



Fits 2630, 2640, 2140, 3140, 1950, 2650, 2750, 2850, 3350, 2555, 2755, 3255, 4050,

RE515684

Replaces RE509896

Injector



Fits 5055E, 5065E, 5075E, 5610, 5303 S/N 103383>, 5403, 5503



FUEL

John Deere

RE32011
Replaces R34764
Injector Seal



R48000
Replaces R34767
Injector Seal



Fits Most Pencil Style Injectors

380426S
Sealing Washer
For Top Cover



568-010
O-RING
For Top Cover Lever Shafts



5393-252U
Seal For CAV Injection
Pump Drive Hub



Fits Most Lucas/CAV Injection Pumps

7135-110
Injection Pump Repair Kit
For CAV DPA Style Pumps

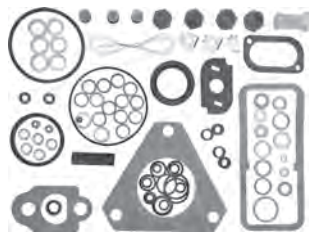

7123-388
Transfer Pump Blade Kit
For CAV DPA Style Pumps



AR50041
Fuel Filter



Fits 820 S/N 173885>, 830, 1530, 2040, 2240, 2630, 2640, 2840, 2940, 3020 S/N 150000>, 4000 S/N 280001>, 4030, 4040, 4230, 4240, 4320, 4430, 4440, 4520, 4620, 4630, 4640, 4840, 5020 S/N 280001>, 6030, 7020, 7520, 8430

DD13483
Fuel Pump
With Metal Top



Fits 820, 920, 1020, 1520, 830, 930, 1030, 1130, 1530, 1630, 2630, 1830, 2040, 2240, 2440, 2640, 2020, 2120, 2030, 2130, 2440, 3120, 3030, 3130, 2150, 2350, 2550, 2750

DD13483S
Fuel Pump
With Glass Bowl



Fits 820, 920, 1020, 1520, 830, 930, 1030, 1130, 1530, 1630, 2630, 1830, 2040, 2240, 2440, 2640, 2020, 2120, 2030, 2130, 2440, 3120, 3030, 3130, 2150, 2350, 2550, 2750

AL78405
Fuel Pump



Fits 3200, 3400, 6010, 6020, 6100, 6110, 6110L, 6120, 6200, 6200L, 6210, 6215, 6220, 6300, 6300L, 6310, 6310L, 6310S, 6320, 6400, 6400L, 6405, 6410, 6410L, 6410S, 6420, 6500L, 6506, 6510, 6510L, 6510S, 6520, 6600, 6605, 6610, 6620, 6800, 6810, 6820, 6900, 6910, 6910S, 6920, 6920S, 7220

AL168483
Fuel Lift Transfer Pump
Tank Mounted



Fits 5215, 5215F, 5215V, 5315, 5315F, 5315V, 5415, 5515, 5515F, 5515V, 5603, 5615, 5615F, 5615V, 5620, 5625, 5720, 5725, 5820, 6020, 6120, 6120L, 6215, 6220, 6220L, 6320, 6320L, 6415, 6420, 6420L, 6420S, 6515, 6520, 6520L, 6615, 6620, 6715, 6820, 6920, 6920S, 7220, 7320, 7420, 7520, SE6020, SE6120, SE6220, SE6320, SE6420, SE6520, SE6620

John Deere

FUEL

AT31619

Fuel Sending Unit



Fits 820, 920, 1020, 1120, 1520, 2020, 830, 1530, 2030, 2130, 2630, 940, 1040, 1640, 2040, 2240, 2440, 2640, 2150, 2350, 2550, 2750, 300, 400, 3040, 3140

AL33498

Fuel Sending Unit



Fits 1640, 1840, 2040, 2140, 2350, 2550, 2750

AT20911

Fuel Tank Cap



Fits 820, 920, 1020, 1520, 830, 930, 1030, 1130, 1530, 1630, 2630, 1830, 2040, 2240, 2440, 2640, 2020, 2120, 2030, 2130, 2440, 3120, 3030, 3130, 2840, 2940, 2150, 2350, 2550, 2750, 2155, 2355, 2555, 2755, 2510, 2520, 300, 300B, 400, 301, 302, 401, 310, 410

AL24219

Replaces AR72910

Fuel Tank
25" Deep



Fits 820, 920, 1020, 1520, 830, 930, 1030, 1130, 1530, 2040, 2240, Early S/N 301, 302, 401

AR72868

Replaces AL24482

Fuel Tank
28" Deep

Fits 2020, 2120, 1630, 2020, 2120, 2030, 2130, 2440

R28794

Pre-Cleaner Bowl
7 1/4" Diameter



R28795

Pre-Cleaner Bowl
10 1/2" Diameter

Fits All Models

PC7-2.25

Pre-Cleaner Assembly
7" Bowl, 2.25" Mount



PC7-2.50

Pre-Cleaner Assembly
7" Bowl, 2.50" Mount



PC10-3

Pre-Cleaner Assembly
10" Bowl, 3" Mount

PC10-3.5

Pre-Cleaner Assembly
10" Bowl, 3.5" Mount



PC10-4

Pre-Cleaner Assembly
10" Bowl, 4" Mount

PC10-4.5

Pre-Cleaner Assembly
10" Bowl, 4.5" Mount

AR84228

Outer Air Filter, Large

AE31724

Inner Air Filter, Small



Fits 830, 930, 1020, 1120, 1130, 1630, 2020, 1140, 1640, 1840, 2040, 2040S, 2120, 1830, 2030, 2130

FUEL & ELECTRICAL

John Deere

12566

Replaces 12522, TSX13, TSX45, TSX60, TSX65, TSX90, TSX89, TSX91, TSX450, TSX516, TSX532, TSX753, TSX802, TSX809, TSX812, TSX860

Carburetor

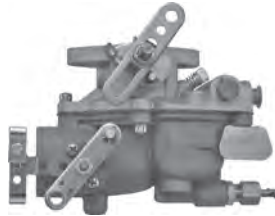

Fits JD L, LA, 1010

A0NN10670A

Replaces FAD10850A 360053R91, 378424R91, 393334R91, 208302
Amp Gauge Chrome



Fits Universal

14997

Replaces TSX759, TSX777, TSX805, TSX817, TSX823, TSX874, TSX929SL, TSX944SL, TSX945SL, TSX951SL, TSX952SL, TSX953SL, TSX969SL

Carburetor



Fits 1520, 2510, 4030

9N9273A

Replaces 506902M1, 9A550, FAD9273A
Oil Pressure Gauge Chrome



Fits Universal

14996

Replaces TSX245, TSX475, TSX530, TSX562, TSX615, TSX678, TSX688, TSX689, TSX704, TSX711, TSX737, TSX756, TSX768, TSX800, TSX808, TSX810, TSX819, TSX877, TSX881, TSX883, TSX885, TSX888, TSX892, TSX894, TSX895, TSX898, TSX899, TSX904, TSX904SL, TSX905, TSX905-1, TSX905SL, TSX906, TSX906SL, TSX907, TSX907SL, TSX908, TSX908SL, TSX920, TSX920SL, TSX921, TSX921SL, TSX922, TSX922SL, TSX923, TSX923SL, TSX938SL, TSX941SL

Carburetor



Fits M, MC, MT, 40, 320, 330, 420, 430, 440, 2010, 1020, 2020, 2510, 300, 400, 350 Crawler, 450 Crawler

UTG25

Temperature Gauge
Adapter is 1/2" - 14 NPT
Probe is 5/8" - 18 thread
6' Cable



Fits Universal

16-RU12

Resistor



Fits Universal

John Deere

ELECTRICAL

SWS259

Spark Plug Wire Set



Fits Most 3 and 4 Cylinder Applications

TY6715

Starter



Fits 670, 770 Tractors 4475, 5575 Skid Steer Loaders

AL30803

Replaces **AL19698, AL24292, AR65445**

Tachometer MPH 19
Will also Replace the
KPH European Tachometers



Fits 820, 920, 1020, 1120, 1520, 2020, 2120, 830, 930, 1030, 1130, 1530, 1630, 1830, 2030, 2130, 2630, 2040, 2240, 2440, 2640, 300, 300B, 301, 301A, 302, 302A, 400, 401A, 401B, 401C, 401D

TY6720

Replaces **TY24305**
Starter



Fits 920, 1020, 1120, 1520, 2020, 3120, 830, 930, 1030, 1130, 1520, 1630, 1830, 2030, 2130, 3130, 1640, 1840, 2040, 2240, 2640, 2840, 3140, 2150, 2350, 2550, 2750, 2950, 3150, 2155, 2355, 2755, 2955, 3055, 6100, 6200, 6300, 6400

AL31829

Gauge Cluster

Fits 940, 1040, 1140, 1640, 1840, 2040, 2040S, 2140, 2150, 2155, 2240, 2255, 2350, 2355, 2355N, 2440, 2550, 2555, 2640, 2750, 2755, 2940, 2950, 3040, 3140



TY6701

Replaces **TY6617, TY6618, TY6713**
Starter



Fits 4000, 4020, 4320, 4620, 7020, 4030, 4230, 4430, 4630, 8430, 4040, 4240, 4440, 4640, 4840, 8440, 4050, 4250, 4450, 4650, 4850, 8450, 8650

AL24293

Manual Temp Gauge
Reads 50-100°
Celsius



AL24526

Electric Temp Gauge



AL24294

Fuel Gauge



Fits 820, 920, 1020, 1520, 830, 930, 1030, 1130, 1530, 1630, 1830, 2030, 2130, 2630, 2040, 2240, 2040, 2240, 2440, 2640, 2020, 2120, 2030, 2130, 2440, 3120, 3030, 3130, 2840, 2940, 2150, 2350, 2550, 2750, 2155, 2355, 2555, 2755, 300, 300B, 400, 301, 302, 401, 310, 410

TY6605

Replaces **AR62401**
Alternator



Fits 820, 1020, 1120, 2020, 2120, 830, 1030, 1530, 1830, 2030, 2040, 2240, 300, 300B, 301, 301A, 302, 302A, 400, 401A, 401B, 401C



COOLING

John Deere

AT20797

Radiator
Core Dimensions: 17" x 18.5"
For Tractors Without Oil Cooler



Fits 820, 920, 1020, 1120, 300, 301

AR90945

Radiator
Core Dimensions:
20" x 13 1/4"
Filler Neck 2"



Fits 2440 S/N 341000>, 2640
S/N 341000>

AT20849

Radiator
Core Dimensions:
13 5/8" x 17 1/8" Tall



Fits 1130, 1530, 1630, 830, 930, 1120, 820,
920, 1020, 2040, 2240, Early S/N

AL39290

Radiator
Core Dimensions:
18 3/4" x 13 1/4"



Fits 840, 940, 1040, 1140, 1350, 1550, 1750,
1850, 2040, 2150, 2155, 2240, 2255, 2355N

AR65715

Replaces AT28810
Radiator
Core Dimensions: 13 5/8" x 20"



Fits 1830, 2630, 2020, 2120, 2030, 2130,
2440, 301, 302, 401, 310, 410

AL37568

Replaces AL31237
Radiator
Core Dimensions:
19" x 20 5/8"



Fits 2350, 2355, 2550, 2555, 2750, 2755

John Deere

COOLING

AR49454

Radiator



Fits 4000 S/N 2001>, Gas and Diesel, 4020 Gas and Diesel, (Will Not Fit LP Gas Tractors)

CH15502

Water Pump



Fits John Deere 650, 750; Yanmar 169, 180, 186, 187, 220, 226, 250, 276, 1301, 1401, 1502, 1510, 1601, 1602, 1610, 1702, 1720, 1802, 1810, 1820, 2001, 2002, 2010, 2020, 2202, 2220, 2301, 2310, 2402, 2420, YMG1800, YMG2000, F14, F15

AL56372

Radiator

Core Dimensions:
20.625" x 19"



Fits 2250, 2355, 2450, 2555, 2650, 2650N, 2755, 2850, 2855N

CH12859

Water Pump



Fits John Deere 850, 950, 1050; Yanmar 336, 1700B, 1900, 2000, 2000B, 2500, 2610, 3110, 3810

AL66774

Radiator

Core Dimensions:
26 7/16" x 19 5/8"



Fits 2250, 2355, 2450, 2555, 2650, 2650N, 2755, 2850, 2855N

AT29619

Replaces **AR97708**,
AR85250

Water Pump with Fittings
Uses Pressed Steel Pulley



Fits 830, 930, 1030, 1130, 1530, 1630, 1830, 2630, 2040, 2240, 2440, 2020, 2120, 2030, 2130, 2440, 2350, 2550, 2750

AR97708

Water Pump



Fits 1030, 1130, 1630, 1830, 2030, 2130

MIA880461

Replaces **AM881340**, **M805843**

Water Pump



Fits 770, 870, 970, 1070, 575 Skidsteer

AR85250

Water Pump



Fits 1830, 2030, 2130, 2630

COOLING

John Deere

AR92418
Replaces RE60489
Water Pump



Fits 1640, 1840, 2040, 2040S, 2140, 2350, 2550, 2750

AR61538
Thermostat



Fits 1140, 840, 940 all with 3179D Engine, 1640, 1840, 2040, 2040S, 2130, 2140, all with 4239D Engine

RE505980
Water Pump
Replaces RE70687,
RE70985, RE500734,
RE500737



Fits 5403, 5605, 5705, 6100, 6110, 6120, 6210, 6215, 6220, 6230, 6310, 6320, 6330, 6403, 6405, 6410, 6415, 6420, 6430, 6603, 6605, 6615, 6715, 7130, 7210, 7220, 7230, 7320, 7330, 7410, 7420, 7430, 7505, 7510, 7515, 7520, 7610, 7710, 7720, 7810, 7815, 7820, 7920, 5065M, 5075M, 5085M, 5095M, 5095MH, 5105M, 6100D, 6110D, 6110L, 6115D, 6125D, 6130D, 6140D, 6210L, 6220L, 6310L, 6310S, 6320L, 6410L, 6410S, 6420L, 6510L, 6510S, 6520L. Combines: 9540, 9550, 9550SH, 9560, 9560SH, 9580. Skidders: 360DC, 360DG, 460DC, 460DG, 540G-III, 548G-III, 640G-III, 648G-III. Dozers: 450J, 550J, 650J, 700H, 700J, 750J. Excavators: 110, 120, 120C, 120D, 160CLC, 160DLC, 160LC, 200CLC, 200DLC, 200LC, 230CLC, 230LC, 230LCR, 230LRD, 270LC, 270CLC, 690ELC. Bunchers: 643H, 643J, 653E, 653G, 740, 840, 843H, 843J. Loaders: 210LJ, 310J, 310SJ, 315SJ, 330B, 335C, 344J, 410J, 430B, 435B, 435C, 437C, 444K, 444J, 524K, 544J, 544K, 624J, 710J, 2254. Graders: 670C, 670CH, 670D, 672CH, 672D. Sprayers: 4700, 4710, 4720. Cotton Pickers: 9970. Cotton Strippers: 7460. Telescopic Handler: 3215, 3220, 3415, 3420, 3800. Logger: 2054, 2554. Wheeled Harvester: 1070D

AT29054
Radiator Cap



Fits 1020, 1120, 1130, 1140, 1630, 1640, 1830, 1840, 2020, 2030, 2040, 2120, 2130, 2140, 2150, 2155, 2350, 2355, 2750, 2755, 2940, 2950, 3030, 3040, 3120, 3130, 820, 830, 840, 920, 930, 940

AT20848
Replaces AR69398, AT77459,
AT165535, AT169229
Transmission Oil Cooler



Fits 820, 920, 1020, 1120, 1520, 2020, 830, 1530, 2030, 2130, 2630, 940, 1040, 1640, 2040, 2240, 2440, 2640, 300, 400

AT22961
Replaces RE33705
Thermostat



Fits 820, 920, 1020, 1120, 1520, 2020, 830, 1530, 2030, 2130, 2630, 940, 1040, 1640, 2040, 2240, 2440, 2640, 300, 400

AL38448
Transmission Oil Cooler



Fits 2350, 2550, 2750, 2950, 3150, 2940, 1640, 1840, 2040, 2040S, 2140, 3040, 3140

John Deere

CLUTCH

AL120011

Replaces **AL36525, AL56308, AL64340**

Clutch Disc
12.625"



Fits 2350, 2550, 2355, 2555, 2040S, 2140

AL120024

Pressure Plate



Fits 2130

AL120012

Replaces **AL33126**

Clutch Disc
10 Spline, 1.250" Diameter



Fits 2550, 2750, 2940, 2950, 2040S, 2140, 3040, 3140

AL68022

Clutch Disc
10 Splines, 5 Pad Button Type



Fits 2350, 2550, 2750, 2950, 3150, 2155, 2355, 2555, 2755, 2955, 2040S, 2140, 3040, 3140

AL120018

Replaces **AL31436, AL33315, AL66180**

Clutch Disc
11"



Fits 2040, 2240 (S/N 350000>), 2150, 2350, 2155, 2355, 1030, 1040, 1130, 1140, 1350, 1550, 1640, 1750, 1850, 1950, 1950N, 2030 (European), 2450, 2450F, 840, 940

AL67974

Clutch Disc
15 Spline, 5 Pad Button Type



Fits 2355, 2555

AL70272

Clutch Disc
10 Splines, 6 Pad Button Type



Fits 2155, 2355, 2555, 2755, 2855, 2955

AL120022

Replaces **AL30151, AL39624, AL40882, AL55140**

Pressure Plate
For Live/Continuous PTO
with 23 Splines



Fits 820, 920, 1020, 1120, 1520, 2020, 2120, 830, 930, 1030, 1130, 1530, 1630, 1830, 2030, 2130, 1140, 1640, 1840, 2040, 2240, 2440, 1850, 1950, 2150, 2350, 2155, 2355

AL68485

Pressure Plate
27 Splines,
1.75" Diameter



Fits 2350, 2550, 2750, 2950, 2155, 2355, 2555, 2755, 2955, 2140, 3040, 3140, 3150, 1040, 1140, 1640, 1840, 2040, 2040S, 2240 (On Models 1040, 1140, 1640, 1840, 2040, 2040S, 2140, 2240, 3040, 3140. The Flywheel Must Be Machined To An Inside Diameter of 13.03" (331mm), In Order To Accept This Clutch)

AL120023

Replaces **AL19048, AL32965, AL36374, AL37703, AL39618, AL56167**

Pressure Plate
For Independent PTO



Fits 1020, 1120, 1520, 2020, 1030, 1130, 1530, 1630, 1830, 2030, 1040, 1140, 1640, 1840, 2040, 2240, 2150

AL39592

Pressure Plate
23 Splines, 1.500" diameter



Fits 940, 1040, 1140, 2150, 2155

PTO & TRANSMISSION

John Deere

CKJD01

Replaces R39244, R57959
Clutch Kit

Includes R42515R PPA with Transmission and PTO Discs, 830701 Transmission Release Bearing, 830664 PTO Release Bearing, 836203 Pilot Bearing, PTO Disc with 15/16" 13 Spline Hub, Transmission Disc with 1 3/8" 19 Spline Hub



Fits 5200, 5210, 5300, 5310, 5310N, 5400, 5410, 5415, 5500, 5500N, 5510, 5510N 5600, 5615, 5700, 5715 collarshift, TSS or synchronized reverser transmissions

AL28738

Clutch Release Bearing



Fits 940, 1040, 1140, 1640, 1840, 2040, 2040 Late, 2240 Late, 2150, 2350, 2550, 2255

AR56268

Replaces 6020, 202SS
Pilot Bearing



Fits 820, 920, 1020, 1520, 830, 930, 1030, 1130, 1530, 1630, 1830, 2030, 2130, 2630, 2040, 2240, 2640, 2020, 2120, 2030, 2130, 300, 400, 301, 302, 401, 310, 410

CKJD02

Replaces R72534U1K, RE211277, RE72534, RE72860, RE73611
Clutch Kit



Includes Pressure Plate Assembly with Captive Trans. Disc, 6 Pad with 1 3/8" 19 Spline Hub, Flywheel Side PTO Disc, 4 Pad with 1" 13 Spline Hub, 830664 PTO Release Bearing, 830701 Transmission Release Bearing, and 836203 Pilot Bearing Flywheel Step Specification .787"

Fits 5045E, 5050E, 5055D, 5055E, 5060E, 5065, 5075E, 5103, 5203, 5210, 5220, 5303, 5310, 5310N, 5320, 5320N, 5403, 5410, 5415, 5420, 5420N, 5425, 5425N, 5503, 5510, 5510N, 5520, 5520N, 5525, 5600, 5603, 5605, 5615, 5625, 5700, 5705, 5715, 5725, 5725N With Collarshift or Synchshuttle Transmission

AR78202

Replaces R53064
PTO/Transmission Support For Independent PTO



Fits 820, 920, 1020, 1120, 1520, 2020, 830, 1530, 2030, 2130, 2630, 940, 1040, 1640, 2040, 2240, 2440, 2640, 2150, 2350, 2550, 2750, 300, 400, 3040, 3140

RE44253

Replaces AR58605
PTO Brake Band



Fits 1020, 1520, 2020, 830, 930, 1130, 1530, 1630, 1830, 2030, 2130, 2630, 2040, 2240, 2440, 2640, 301A, 401B, 401D

AL27231

Clutch Release Bearing and Hub



Fits 820, 920, 1020, 1120, 2020, 2120, 830, 930, 1030, 1130, 1630, 1830, 2030, 2130, 3030, 3130, 2040, 2240, 2840

John Deere

PTO & TRANSMISSION

AL69761

Replaces AL39355,
AL28923

Transmission Pump

Fits 940, 1040, 1140,
2240, 2440, 2640, 2940,
3040, 3140, 2150, 2350,
2550, 2750, 2950, 2155, 2355, 2555, 2755, 2855, 2955



T22219

PTO Input Shaft



Fits 820, 920, 1020, 1520, 830, 930, 1030, 1130, 1530,
1630, 1830, 2040, 2240, 2440, 2020, 2120, 2030, 2130,
2440, 300, 300B, 400, 301, 302, 401, 310, 410

AL69762

Transmission Pump
For Tractors With SGB

Fits 2355, 2555, 2755, 2855,
2955, 3150, 3155



R50864

Shift Knob



L31055

Shift Boot



Fits 820, 920, 1020, 1520, 830, 930,
1030, 1130, 1530, 1630, 1830, 2030,
2130, 2630, 2040, 2240, 2040, 2240, 2440, 2640, 2020,
2120, 2030, 2130, 2440, 3120, 3030, 3130, 2840, 2940,
2150, 2350, 2550, 2750, 2155, 2355, 2555, 2755, 300,
300B, 400, 301, 302, 401, 310, 410

AR96662

Replaces R39244, R57959

Transmission Pump
1/2" Thick Gears

Fits 820, 920, 1020, 1520, 830,
930, 1030, 1130, 1530, 1630,
1830, 2030, 2130, 2630, 2040, 2240, 2640, 2020, 2120,
2030, 2130, 2440, 2150, 2155, 2355, 2555, 2755, 300,
300B, 400, 301, 302, 401, 310, 410



AL55218

Shifter Shaft

Has Hole For Connecting Linkage



Fits 2140, 3040, 3140, 2350, 2550, 2750, 2950, 3150,
2355, 2555, 2755, 2955, 3055, 3155, 3255

AR96664

Replaces R52526, R57962

Transmission Pump

Fits 1520, 2130, 2630, 2440,
2640



AL36354

Shifter Shaft

Has knob For Connecting Linkage



Fits 2140, 2940, 2350, 2550, 2750

AT26669

Replaces T28697

John Deere Gear Set for Transmission Pump
Includes AT26669 and T28697. Gears are
0.710" thick.

Fits 2840, 3120, 3030, 3130



L36621

Seal

For John Deere
Shifter Shaft

Fits 2140, 2940, 3040, 3140, 2350, 2550,
2750, 2350, 2550, 2750, 2950, 3150, 2355, 2555, 2755,
2955, 3055, 3155, 3255



PTO & TRANSMISSION

John Deere



R33512
Transmission Drive Shaft

Fits 2510, 2520, 3020, 500, 500A, 500B

R33384
Transmission Drive Shaft

Fits 4000, 4020

R59641
Replaces R44637, R51518
Pinion, Low Range



Fits 4000, 4020, 4230, 4430

R31026
High-Low Range Drum



Fits 2010, 2510, 2520, 3010, 3020, 4010, 4000, 4020, 4320, 4030, 4230, 4430

R52499
Replaces R31027
Reverse Range Drum



Fits 2510, 2520, 3010, 3020, 4010, 4000, 4020

R33382
Reverse Range Shift Collar



Fits 4000, 4020

R33383
High-Low Range Shift Collar



Fits 4000, 4020

AT16550
Replaces AT10746,
M3591T, M4205T
Cluster Gear
19/26/43 Teeth



Fits 40, 420, 430, 1010

T13512
PTO Gear
28 Teeth



Fits 1010, 2010

LVB25153
Creeper Gear Kit



Fits 5210, 5310, 5410, 5510, 5220, 5320, 5420, 5520, 5083E, 5083EN, 5093E, 5093EN, 5101E Limited Tractor, 5101EN, 5225, 5325, 5225, 5320N, 5420N, 5520N, 5325, 5325, 5325N, 5325N, 5425N, 5525N, 5425, 5425, 5525, 5625, 5425, 5525, 5525N, 5603, 5625

John Deere

PTO & DIFFERENTIAL

T21996

PTO Bearing Housing



Fits 820, 920, 1020, 1120, 1520, 2020, 830, 1530, 2030, 2130, 2630, 940, 1040, 1640, 2040, 2240, 2440, 2640, 300, 400

R47514 ~~X~~

Replaces T22237
PTO Bearing Quill



Fits 820, 920, 1020, 1120, 1520, 2020, 830, 1530, 2030, 2130, 2630, 940, 1040, 1640, 2040, 2240, 2440, 2640, 300, 400

R41756

540 RPM Shaft
10.687" Long
6 Splines



Fits 2840, 2940, 2950, 2955, 3030, 3040, 3050, 3055, 3120, 3130, 3140, 3150, 3155, 3255, 3350, 3650, 4055, 4255, 4350, 4555

L29227

Replaces T21876
Differential Spider Gear
11 Teeth



Fits 820, 920, 1020, 1520, 830, 930, 1030, 1130, 1530, 1630, 1830, 2030, 2130, 2630, 2040, 2240, 2640, 2020, 2120, 2440, 2150, 2155, 2355, 2555, 2755, 300, 300B, 400, 301, 302, 401, 310, 410

L156976

PTO Shaft
9.2" Long
6/21 Reversible Spline
30 Center Splines



Fits 5225, 5325, 5425, 5525, 6110, 6210, 6310, 6410, 6510, 6403, 6405, 6603, 6605, 7200, 7210, 7400, 7405, 7410, 7420, 7505, 7510, 7515, 7520, 7600, 7610, 7700, 7710, 7720, 7800, 7810, 7815, 7820, 7920

L29226

Replaces T21875
Differential Cross Shaft



Fits 820, 920, 1020, 1520, 830, 930, 1030, 1130, 1530, 1630, 1830, 2030, 2130, 2630, 2040, 2240, 2640, 2020, 2120, 2440, 2150, 2155, 2355, 2555, 2755, 300, 300B, 400, 301, 302, 401, 310, 410

L173284

PTO Shaft
9.2" Long
6/21 Reversible Spline
14 Center Splines



Fits 6120, 6120L, 6215, 6220, 6220L, 6230, 6320, 6320L, 6330, 6415, 6420, 6420L, 6430, 6520L, 6615, 6715

T29394

Replaces T21971
Differential Side Gear
18 Teeth



Fits 820, 920, 1020, 1520, 830, 930, 1030, 1130, 1530, 1630, 1830, 2030, 2130, 2630, 2040, 2240, 2640, 2020, 2120, 2440, 2150, 2155, 2355, 2555, 2755, 300, 300B, 400, 301, 302, 401, 310, 410

L38806

Replaces L28712
PTO Shaft
For Standard PTO 540



Fits 820, 920, 1020, 1120, 1520, 2020, 830, 1530, 2030, 2130, 2630, 940, 1040, 1640, 2040, 2240, 2440, 2640, 300, 400

L40557

Ring Gear Rivet, 7/16"

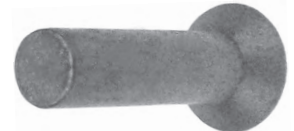

T152922

Ring Gear Rivet, 1/2"

Fits 820, 920, 1020, 1520, 830, 930, 1030, 1130, 1530, 1630, 1830, 2030, 2130, 2630, 2040, 2240, 2640, 2020, 2120, 2440, 2150, 2155, 2355, 2555, 2755, 300, 300B, 400, 301, 302, 401, 310, 410

DIFFERENTIAL

John Deere



DIFF00

Differential Assy
7/16" Rivet Holes
A: Has 2.250" Bearing Surface
Diameter on R/H Housing

DIFF01

Differential Assy
7/16" Rivet Holes
A: Has 2.687" Bearing Surface
Diameter on R/H Housing

DIFF02

Differential Assy
1/2" Rivet Holes
A: Has 2.687" Bearing Surface
Diameter on R/H Housing

Fits 820, 920, 1020, 1520, 830, 930, 1030, 1130, 1530, 1630, 1830, 2030, 2130, 2040, 2020, 2120, 2030, 2130, 2440, 2150, 2155, 2355, 2555, 2755, 300, 300B, 400, 301, 302, 401, 310, 410

DIFF03

Differential Assy
7/16" Rivet Holes
A: Has 2.687" Bearing Surface
Diameter on R/H Housing

DIFF04

Differential Assy
1/2" Rivet Holes
A: Has 2.687" Bearing Surface
Diameter on R/H Housing

Fits 2630, 2440, 2640

R51500

Differential Housing, L/H



Fits 820, 920, 1020, 1520, 830, 930, 1030, 1130, 1530, 1630, 1830, 2030, 2130, 2630, 2040, 2240, 2640, 2020, 2120, 2030, 2130, 2440, 2150, 2155, 2355, 2555, 2755, 300, 300B, 400, 301, 302, 401, 310, 410



T24382

R/H Differential
Housing 7/16" Rivet Holes
A: 2.250" Bearing Surface
Diameter on R/H Housing



T59690

R/H Differential
Housing 7/16" Rivet Holes
A: Has 2.687" Bearing Surface
Diameter on R/H Housing

T30253

R/H Differential
Housing 1/2" Rivet Holes
A: Has 2.687" Bearing Surface
Diameter on R/H Housing

Fits 820, 920, 1020, 1520, 830, 930, 1030, 1130, 1530, 1630, 1830, 2030, 2130, 2630, 2040, 2240, 2640, 2020, 2120, 2030, 2130, 2440, 2150, 2155, 2355, 2555, 2755, 300, 300B, 400, 301, 302, 401, 310, 410

John Deere

FRONT AXLE, TIE ROD ENDS

AT27130

Inner Tie Rod
A - 5.000"
B - 1.125" I.D. Thread



Fits 820, 830, 840, 920, 930, 940, 1020, 1120, 1130, 1140, 1520, 1530, 1630, 1640, 1840, 2020, 2030, 2040, 2120, 2150, 2240, 2255, 2440, 2630, 2640, 300, 301, 400, 401, 301A, 302, 401B

AL82826

Replaces, **AL27532, AL37504**
Tie Rod
3.880" Long
24mm dia - 1.5" Thread



Fits 1830, 1840, 2030, 2040, 2040S, 2130, 2140, 2250, 2350, 2355, 2450, 2550, 2555, 2650, 2750, 2755, 2850

AT23886

Inner Tie Rod
A - 5.000"
B - 1.000" I.D. Thread



Fits 1020, 1520, 1530, 2020, 2030, 2240, 2440, 2630, 2640, 300, 400

AL37505

Tie Rod End
6 Notches
A - 12.620"
B - .865"



Fits 1640, 1830, 1840, 2030, 2040, 2040S, 2130, 2140, 2250, 2350, 2355, 2450, 2550, 2555, 2650, 2755, 2850, 2940, 2955, 3055, 3255

AT23583

Outer Tie Rod
15 Grooves
A - 17.250"
B - .750"



Fits 1020, 1520, 1530, 2020, 2030, 2040, 2240, 2440, 2630, 2640

AL39319

Tie Rod End
A - 11.250"
B - 18 x 1.5mm
R/H Thread



Fits 2140, 2350, 2355, 2550, 2555, 2750, 2755, 2850, (1640, 2040, 2040S all S/N 430000>)

AT23885

Long Tie Rod
11 Notches
A - 12.250"
B - .781"



Fits 830, 840, 930, 940, 1020, 1120, 1140, 1530, 2020, 2030, 2040, 2150, 2240, 2255, 2440, 2630, 2640, 300, 301, 400, 401, 301A, 302, 401B

AL39320

Tie Rod End
A - 7"
B - 20 x 1.5mm R/H Thread
C - 18 x 1.5mm R/H Thread



Fits 2140, 2350, 2355, 2550, 2555, 2650, 2750, 2850, (1640, 2040, 2040S all S/N <430000)

AT27134

Outer Tie Rod
13 notches
A - 14.509"
B - .781"



Fits 840, 940, 1020, 1120, 1130, 1140, 1520, 1530, 1630, 1640, 2020, 2030, 2120, 2240, 2440, 2630, 2640, 301, 401

T29109

Tie Rod Tube
12.218" Long
.812" I.D.
1.125" - 12 O.D. Thread



Fits 840, 940, 1020, 1120, 1130, 1140, 1520, 1530, 1630, 1640, 2030, 2120, 2150, 2155, 2240, 2350, 2355, 2550, 2555, 2630, 2640, 2755, 2020 Swept Back Axle, 301, 401



FRONT AXLE, TIE ROD ENDS

John Deere

AL68254

Tie Rod, L/H
A - 10.750"
B - 28 x 1.5mm
R/H Thread



Fits 2955, 3050, 3055, 3150, 3155, 3255, 3350, 3640, 3650 All With MFWD, (3040, 3140 All With MFWD S/N 430000>)

AR27351

Short Inner Tie Rod



AR51584
Replaces AR27350
Long Outer Tie Rod



Fits 2510, 2520, 3010, 3020, 4000, 4010, 4020, 4230 4320

AL68255

Tie Rod, R/H
A - 10.750"
B - 28 x 1.5mm
R/H Thread



Fits 2955, 3040, 3050, 3055, 3140, 3150, 3155, 3255, 3350, 3640, 3650 All With MFWD

AR63588

Inner Tie Rod



AL60161

Replaces AL39316
Tie Rod



A - 8.250"
B - 22 x 1.5mm R/H Thread
C - 24 x 1.5mm R/H Thread

AR63592

Outer Tie Rod
8 Cross Holes



Fits 4030, 4040, 4050, 4055, 4230, 4240, 4250, 4255, 4430, 4440, 4450, 4455 ALL with Regular Wide Front End

Fits 2140, 2750, 2950, 3040, 3050, 3140, 3350, 210C, 300D, 310C, 310D, 315C, 315D, 410C, 410D, 482C, 510C, 510D, 610C

AR63590

Short Tie Rod



AL58013

Tie Rod End, L/H



AR63587

Long Tie Rod
9 Cross Holes



Fits 4640 S/N <2436 with Power Front Axles, 3630, 4040, 4230, 4250, 4430, 4440 all with MFWD

AL58014

Tie Rod End, R/H
A - 11.750"
B - 24 x 1.5mm
R/H Thread



AL37523

Replaces AL34262
Tie Rod End
For MFWD



Fits 2040S, 2140, 2940, 3040, 3140

Fits 3050, 3350, (2140, 2750 all Axle S/N 024906>), (2950, 3040, 3140 All Axle S/N 026317>)



John Deere

STEERING, DRAG LINKS, P/S ADD ON KITS

Drag Links



AR68818

Replaces AT19808, AL39036

Drag Link

Ball Joint Ends are Rotated 90°

A - 35.781"

B - 1.000"

Fits 820, 830, 1020, 1520, 1530, 2040, 2240, 300, 301, 310

AR91711

Replaces AT33297, AL19047,

AL38636, AL39035

Drag Link

Ball Joint Ends are Rotated 90°

A - 40.750"

B - 1.062"

Fits 2020, 2030, 2440, 2630, 2640 S/N <340999, 401

AL38638

Replaces AL31090, AL34935

Drag Link

Fits 1640, 1840, 2040, 2040S, 2140, 2350, 2550, 2355, 2755

AL39026

Replaces AT26382, AL38641

Drag Link

Fits 2840, 3120, 3130

LEVERPIN01

Bellcrank Pin



Fits 2030 S/N <187300 with Swept Back Adjustable Axle, (440, 2460 2640 all S/N <308804 with Swept Back Adjustable Axle), (2040, 2240 all S/N <349999 with Swept Back Adjustable Axle), 300, 301, 400, 401, 1020, 1520, 1530, 2020, 2630, 820, 830 all with Swept Back Adjustable Axle

LEVERPIN02

Bellcrank Pin



Fits 2440, 2640 all S/N <308804 with 49-79" Swept Back Adjustable Replacement Axle, 2040, 2240 all S/N <349999 with Swept Back Adjustable Axle), 1530 with Straight or Swept Back Adjustable Axle, 301, 401, 2630, 820, 830 all with Swept Back Adjustable Axle, 1020, 2020 all with 44-66" or 48-78" Swept Back Adjustable Axle, 1520 with 48-78"

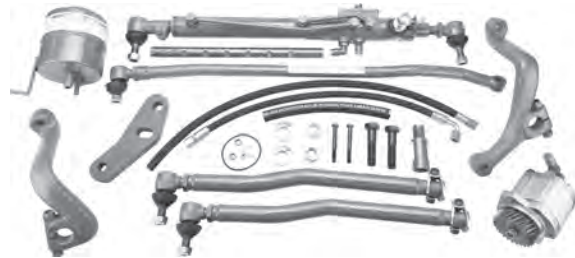

JDPSKIT01

JD Power Steering Kit
All 3 Cylinder Tractors

Fits 820, 830, 920, 930, 1020, 1030, 1520, 1530

JDPSKIT02

JD Power Steering Kit
All 4 Cylinder Tractors

Fits 2020, 2030, 2120, 2130

STEERING, STEERING VALVES, MISC

John Deere

AL28458
Replaces L28988
 Steering Wheel
 Deep Dish

Fits 2120, 2130, 3130



AL28457
Replaces T22875
 Steering Wheel
 Shallow Dish

Fits 820, 830, 1020, 1520, 2020, 1030, 1530, 2030, 2130, 2630, 2040, 2240, 2640, 2150, 2350, 2155, 2355, 300, 400, 310, 401, 302

L29199
 Power Steering Shaft



Fits 820, 830, 1020, 1520, 2020, 1030, 1530, 2030, 2130, 2630, 2040, 2240, 2640, 2150, 2350, 2155, 2355, 300, 400, 310, 401, 302

AT26188
Replaces AT315816
 Seal Kit
 For Power
 Steering Sector

Fits 820, 830, 1020, 1520, 2020, 1030, 1530, 2030, 2130, 2630, 2040, 2240, 2640, 2150, 2350, 2155, 2355, 300, 400, 310, 401, 302

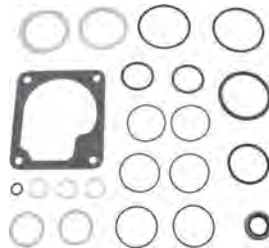

AL31515
 Power Steering Unit
 (For Tractors with
 Closed Center
 Hydraulics)

Fits 1020, 1520, 2020, 1030, 1530, 2030, 2130, 2630, 2040, 2240, 2640, 2150, 2350, 2155, 2355, 300, 400, 310, 401, 302



AL55954
 Steering Motor

Fits (1640, 1840, 2040, 2040S, 2140, 3040, 3140 S/N <429999) (2140, 3040, 3140 S/N 430000>) and 2940



AL55956
 Steering Motor

Fits (2140, 3040, 3140 S/N <429999) (2140, 3040, 3140 S/N 430000>) and 2940



RE239222
Replaces RE197078
 Steering Motor

Fits 5300, 5300, 5400, 5500, 5210, 5310, 5410, 5510, 5220, 5320, 5420, 5520, 5103, 5203, 5303, 5403, 5105, 5105M, 5105ML, 5205, 5415, 5415H, 5615, 5715, 5715H, 5425, 5525, 5625, 5725, 5045D, 5055D, 5101E, 5065M, 5075M, 5085M, 5095M, 5083-340000, 5093-340000



AT61108
Replaces 212 1002 001,
AL59899, AL59900,
AL59975
 Steering Motor
 For 2WD tractors

Fits Early Models 2350, 2550, 2750, 2950, 2355, 2555, 2755, 2955, 3040, 3140



AL61553
Replaces
AL112919,
AL34542,
AL36565, RE17356
 Power Steering Cylinder

Fits 2140 (ASN 430000), 2350, 2355, 2550, 2555, 2750, 2755, 2950, 3140 (BSN 449999), 6500, 6200L, 6300L, 6400L, 6500L



John Deere

FRONT AXLE, SPINDLES & HUBS

AR55180

Spindle, L/H-R/H

- A - 12.250"
- B - 1.464"
- C - 1.464"
- D - 1.375"
- E - .750"

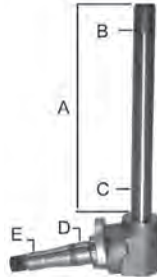

Fits 2510, 3010, 4010, 2520 S/N 022001>, 3020, 4000, 4020, 4320 All Row Crop

AR58607

Spindle, L/H-R/H



- A - 12.475"
- B - 1.375"
- C - 1.375"
- D - .842"



Fits 940, 1020, 1030, 1040, 1120, 1130, 1140, 1550, 1630, 1750, 1850, 1950, 1950N, 2020, 2120, 2155, 2355N

AL28222

Spindle, L/H-R/H



- A - 14.875"
- B - 1.500"
- C - 1.795"
- D - 1.312"

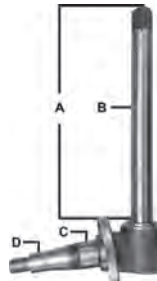

Fits 1040, 1130, 1140, 1550, 1630, 1640, 1750, 1830, 1840, 1850, 1950, 2030, 2040, 2140, 2250 (with 44.5mm King Pin), 2350, 2355, 2450, 2550, 2555, 2650, 2755 (HI-Version), 2850

AR103473

Replaces AR52862, AR58608

Spindle, L/H-R/H



- A - 9.875"
- B - 1.375"
- C - 1.375"
- D - .842"

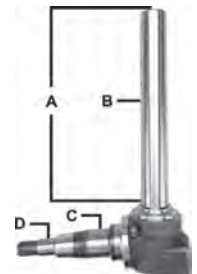

Fits 820, 830, 1020, 1520, 1530, 1641F, 202, 2030 S/N <187300, 2040, 2240, 2355N with 44" Tread

AR58606

Spindle, L/H-R/H



- A - 11.875"
- B - 1.375"
- C - 1.375"
- D - .842"



Fits 820, 830, 840, 920, 930, 940, 1020, 1030, 1040, 1120, 1130, 1140, 1350, 1550, 1630, 1640, 1750, 1840, 1850, 1950, 2020, 2040, 2140, 2150, 2155, 2255 (Swept Back), 2350 (Low Profile), 2355, 2450, 2550, 2555, 2755 (MID-HI Axle), 2855

T25809

Front Hub



Fits 820, 920, 1020, 1520, 830, 930, 1030, 1130, 1530, 1630, 1830, 2030, 2130, 2630, 2040, 2240, 2640, 2020, 2120, 2030, 2130, 2440, 2150, 2155, 2350, 2550, 2750, 2355, 2555, 2755, 300, 300B, 400, 301, 302, 401, 310, 410

LVA19816

Replaces LVU20858, LVU20859

Side Gear Kit
11 Tooth & 14 Tooth Gears



LVA19824

Replaces LVU20860, LVU20862

Bevel Gear Kit
12 Tooth & 41 Tooth Gears

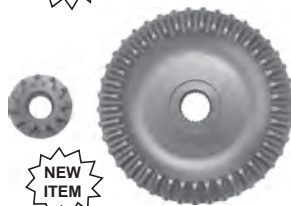

Fits 3032E, 3036E, 3038E

R48763

Front Hub



Fits 1520, 2510, 2520, 3010, 4010, 3020, 4020, 4320, 4030, 4230, 4040, 4240, 4430

HYDRAULICS, PUMP PARTS

John Deere

For Piston Pumps with Keyed Shafts

R39319
Hydraulic Pump Shaft



R39073
Needle Roller



R63629
Bearing Race



R66164
Thrust Washer



JD9858
Needle Bearing



AR39041
Spring Kit
(8 springs)



Fits 820, 920, 1020, 1520, 830, 930, 1030, 1130, 1530, 1630, 1830, 2030, 2130, 2630, 2040, 2240, 2440, 2640, 2020, 2120, 2030, 2130, 2440, 3120, 3030, 3130, 2840, 2940, 2150, 2350, 2550, 2750, 2155, 2355, 2555, 2755, 300, 300B, 400, 301, 302, 401, 310, 410

R105583
Replaces R39067
Seat



R68553
Replaces R39075
Insert



RE23382
Valve



R72936
Valve Seat



R39180
Valve



R68384
Replaces R40756
Control Valve



R63022
Replaces R39068
Piston



R49297
Disc



AR98993
Seal Kit

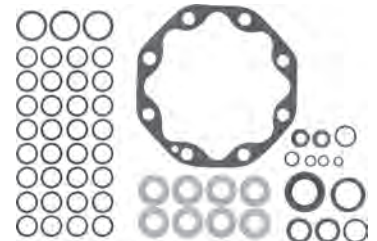

John Deere

HYDRAULICS, HYDRAULIC PUMPS

AR55346

Hydraulic Pump
For Tractors with Power Steering & Open Center Hydraulics 3.93" Center to Center on Ports



AL37750

Hydraulic Pump
For Tractors with Power Steering & Open Center Hydraulics 3.53" Center to Center on Ports

Fits 820, 830, 2040

RE68886

Replaces RE197623, RE57445
Tandem Hydraulic Pump



Fits 5200, 5300, 5400, 5210, 5310, 5410, 5105, 5205

RE73947

Replaces RE72058
Hydraulic Pump



Fits 5410, 5510, 5510N, 5420, 5520, 5425, 5725N, 5425N, 5415, 5415H, 5715, 5715HC, 5076E, 5076EF, 5076EL, 5082E, 5083E, 5083E, 5090E, 5090EH, 5090EL, 5093E, 5093E, 5101E, 5603, 5605, 5615, 5705

AR103033

Replaces AR103036
Hydraulic Pump
8 Piston, Keyed Shaft



Fits 1020, 1520, 2020, 1530, 2030, 2630, 3120, 3130, 2120, 2130, 2140, 2040, 2240, 2440, 2640, 2840, 2150, 2350, 2550, 2750, 2155, 2355, 2555, 2755

AT31208

Hydraulic Pump



Fits 350, 350B, 450, 450B

AR90459

Replaces AR39168, AR97872, R45228
Hydraulic Pump
CONFIRM ALL PORT MEASUREMENTS BEFORE ORDERING



Top Inlet: 7/8"
Right Inlet: 1 5/8"
Left Inlet: 1 1/16"
Discharge: 7/8"
40cm 2.4 CI Displacement

Fits 2510, 3010, 4010, 5010, 2520, 3020, 1830, 2030, 2130, 2630, 3030, 3130, 4030, 1640, 1840, 2040, 2040S, 2140, 2440, 2640, 2840, 2940, 3040, 3140, 3640, 1550, 1750, 1850, 1950, 2250, 2350, 2155, 2355, 2555, 2755, 2855, 2955, 3055, 3155, 3255, 300, 440, 440A, 440B, 500, 600, (9950, 9960, 9965, 9970 Cotton Pickers)

AR94660

Hydraulic Pump
CONFIRM ALL PORT MEASUREMENTS BEFORE ORDERING

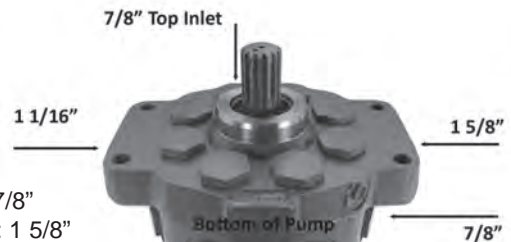

Top Inlet: 7/8"
Right Inlet: 1 5/8"
Left Inlet: 1 1/16"
Discharge: 7/8"
50cm, 3.0 CI Displacement

Fits 2510, 3010, 4010, 5010, 2520, 3020, 1830, 2030, 2130, 2630, 3030, 3130, 4030, 1640, 1840, 2040, 2140, 2440, 2640, 2840, 2940, 3040, 3140, 3640, 1550, 1750, 1850, 1950, 2250, 2350, 2550, 2650, 2750, 2850, 2950, 3050, 3150, 3350, 3650, 2155, 2355, 2555, 2755, 2855N, 2955, 3055, 3155, 3255, 300, 500, 600, 300, Cotton Pickers 9950, 9960, 9965, 9970

HYDRAULICS, HYDRAULIC PUMPS

John Deere

AR94661

Hydraulic Pump

CONFIRM ALL PORT MEASUREMENTS BEFORE ORDERING



Top Inlet: 7/8"
 Right Inlet: 1 1/16"
 Left Inlet: 1 1/16"
 Discharge: 1 1/16"
 65cm, 4.0 CI Displacement

Fits Tractors With MFWD 4000, 4020, 4040, 4230, 4240, 4320, 4430, 4440, 4520, 4620, 4630, 4640. Farm Tractor: 4555, 4650, 4755, 4850, 4955. Four Wheel Drive Tractors: 8430, 8440, 8450, 8630, 8640, 8650

AR101288

Hydraulic Pump

CONFIRM ALL PORT MEASUREMENTS BEFORE ORDERING

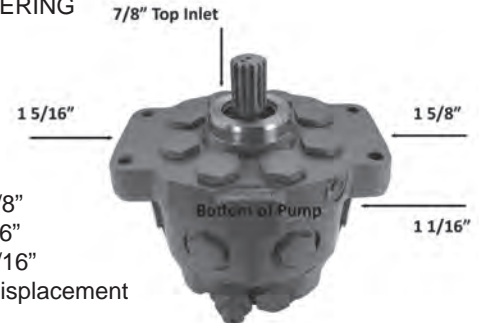

Top Inlet: 7/8"
 Right Inlet: 1 5/8"
 Left Inlet: 1 5/16"
 Discharge: 1 1/16"
 65cm, 4.0 CI Displacement

Fits 310B, 410, 500C, 640, 670, 740, 740A

AR49427

Replaces AR45822

Hydraulic Pump Drive Bushing



R34360

Screw

Fits 830, 930, 1020, 1030, 1120, 1130, 1520, 1530, 1630, 1830, 2020, 2030, 2040, 2120, 2130, 2240, 2440 (Prior S/N 340999), 2510, 2520, 2630, 2640 (Prior S/N 340999), 2840, 3020, 3030, 3120, 3130, 4000 (Post S/N 201000), 4020 (Prior S/N 200999), 4030, 4040, 4230, 4240, 4320, 4430, 4440, 4455, 4520, 4620, 4630, 4640, 4840, 5010, 5020, 6030, 7020, 7520, 8430, 8440, 8630, 8640. Industrials: 300, 300B, 301, 301A, 302, 302A, 310, 310A, 310B, 400, 401, 401B, 401C, 410, 500, 500A, 500B, 500C, 510, 600. Combines: 9400. Cotton Pickers: 9940. Loaders: 444, 544, 544A, 544B, 644A, 644B. Skidders: 440, 440A, 440B, 440C, 540, 540A, 540B, 640, 740. Scrapers: 700A, 760A, 762. Graders: 570, 570A, 670, 670A, 672A, 770, 770A, 770AH. Forklifts: 380, 480A, 480B, 480C

AR101807

Replaces R101807

Hydraulic Pump

CONFIRM ALL PORT MEASUREMENTS BEFORE ORDERING

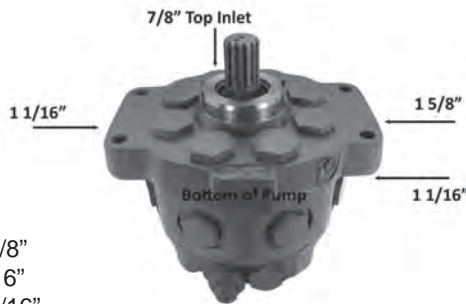

Top Inlet: 7/8"
 Right Inlet: 1 5/8"
 Left Inlet: 1 1/16"
 Discharge: 1 1/16"
 50cm, 3.0 CI Displacement

Fits 1640, 2040, 2140, 2955, 3010, 3020, 4000, 4010, 4020, 4040, 4050, 4230, 4240, 4250, 4430, 4440, 4450, 4520, 4620, 4630, 5010, 5020, 7020, 7520, 300, 300B, 302A, 310, 340D, 400, 401, 401C, 401D, 440, 440C, 440D, 444, 448D, 500, 510, 540, 540B, 540D, 544, 548D, 570, 570B, 600, 640, 640D, 644, 646, 700A, 760

R38348

Coupler Half



Fits (830, 930 S/N 258366 and Up), 1020, 1120, 1130, 1520, 1530, 1630, 1640, 1830, 2020, 2030, 2040, 2120, 2130, 2140, 2240, 2440, 2510, 2520, 2630, 2640, 1030, 3030, 3120, 3130, 300, 300B, 301, 400, 301A, 302, 401B, JD380, 401C, 480C



John Deere

HYDRAULICS, LOAD SHAFTS & PUMP SEAL KITS

AL40976

Load Control Shaft Kit



Fits 1830, 2030, 2130, 2040S, 2140, 2350, 2550, 2750

AL40977

Load Control Shaft Kit



Fits 1830, 2030, 2130, 2040S, 2140

L26932

Replaces T26598

Load Control Shaft
19.690" Long, .815" Dia



T22097

Load Shaft Bushing



T22099

Load Control Outer Bushing



Fits 1020, 1120, 1130, 1140, 1530, 2040, 2240, 2150, 2155, 2255, 2355, 300B, 302, 840, 940, 302, 301A, 300, 301

L31199

Sensing Shaft



Fits (1830, 2030, 2130 S/N 172687>, 1640, 1840, 2040, 2040S, 2140, (2350, 2550, 2750 S/N 529511>)

AR98993

Hydraulic Pump Seal Kit
For 12 CM3 (1.38 IN .3)
Pumps (Keyed Shaft)

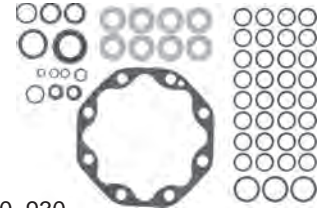

Fits 820, 920, 1020, 1520, 830, 930, 1030, 1130, 1530, 1630, 1830, 2030, 2130, 2630, 2040, 2240, 2440, 2640, 2020, 2120, 2030, 2130, 2440, 3120, 3030, 3130, 2840, 2940, 2150, 2350, 2550, 2750, 2155, 2355, 2555, 2755, 300, 300B, 400, 301, 302, 401, 310, 410

RE29103

Replaces AR67718

Hydraulic Pump Seal Kit
For 39CM3 (2.4 IN .3) and 49CM (3 3 IN .3) Pumps

Fits 3010, 4000, 4010, 4020, 4040, 4055, 4240, 4320, 4440, 4455, 4520, 4620, 4630, 4640, 4650, 4840, 4850, 5010, 5020, 6030, 7020, 7520, 8430, 8630

RE29107

Replaces AR96321

Hydraulic Pump Seal Kit
For 40CM3 (2.4 IN .3) and 50 CM3 (3 IN .3) Pumps

Fits 1830, 2030, 2130, 2155, 2350, 2355, 2520, 2550, 2555, 2630, 2750, 2755, 2840, 2950, 2955, 3010, 3020, 3030, 3055, 3130, 3150, 3155, 3255, 4000, 4010, 4020, 4030, 4040, 4050, 4055, 4230, 4240, 4250, 4255, 4320, 4430, 4440, 4450, 4455, 4520, 4620, 4630, 4640, 4840, 5010, 5020, 7020, 7520, 300B, 302A, 310A, 310B, 340D, 401C, 401D, 440D, 444C, 510, 540D, 544C, 570B, 640D, JD310, JD400, JD401, JD440, JD444, JD500, JD540, JD544, JD570, JD600, JD644, JD646, JD700A, JD760

RE29109

Replaces AR96323

Hydraulic Pump Seal Kit
For 65 CM3 (4 IN .3)

Fits 310B, 3140, 4000, 4020, 4040, 410, 4230, 4240, 4320, 4430, 4440, 4520, 4555, 4560, 4620, 4630, 4640, 4650, 4755, 4760, 4850, 4955, 4960, 500C, 510B, 610B, 640, 644C, 646C, 670A, 670B, 672A, 672B, 762A, 770A, 770B, 772A, 772B, 8430, 8440, 8450, 8630, 8640, 8650, JD670, JD740, JD762

HYDRAULICS, LINES & FILTERS

John Deere

AT22143

Hydraulic Line
Oil Cooler to Clutch Housing



Fits 1830, 2030, 2130, 2630, 2440, 2640, 401B, 401C, 401D

AL19753

Brake Line, L/H



Fits 1830, 2030, 2130

AT22145

Hydraulic Line
Reservoir to Clutch Housing



Fits 820, 920, 1020, 1520, 830, 930, 1030, 1530, 1630, 2040, 2240, 2150, 2155, 300, 300B, 301, 301A, 302, 302A

AT34670

Replaces AR28271,
AR75601, AR75603
Hydraulic Filter



AT23562

Hydraulic Line
For Tractors With Power Steering



Fits 1830, 2020, 2120, 2030, 2130, 2440, 2630, 2640, 400, 401B

R53169

Transmission Filter Screen



Fits 820, 830, 1020, 1520, 1640, 1840, 1950N, 2020, 2030, 2040, 2040S, 210C, 2150, 2155, 2250, 2251N, 2350, 2355N, 2440, 2450, 2510, 2550, 2555, 2630, 2640, 2750, 2755, 2840, 2940, 2950, 300B, 300D, 301A, 302, 302A, 3040, 401B, 401C, 2520, 3010, 4010, 4020

AT22080

Hydraulic Line



Fits 2020, 2120, 1830, 2030, 2130, 400, 401, 401B

AL60565

Replaces AL27221
Quadrant Shaft



Fits 830, 930, 1030, 1130, 1630, 1830, 2030, 2130, 940, 1040, 1140, 1640, 1840, 2040, 2040S, 2140, 2150, 2350, 2255, 2550, 2750

AL19705

Brake Line, R/H



Fits 1830, 2030, 2130

John Deere

HYDRAULICS, HITCH

AR44551

Leveling Assy, R/H
17.5" Rod



AR44554

Leveling Assy, L/H
17.5" Rod



Fits 820, 920, 1020, 1520, 830, 930, 1030, 1130, 1530, 1630, 1830, 2030, 2130, 2630, 2040, 2240, 2640, 2020, 2120, 2030, 2130, 2440, 2150, 2155, 2350, 2550, 2750, 2355, 2555, 2755, 300, 300B, 400, 301, 302, 401, 310, 410

AR44552

Leveling Assy, R/H
15" Rod



AR44556

Leveling Assy, L/H
15" Rod



Fits 820, 920, 1020, 1520, 830, 930, 1030, 1130, 1530, 1630, 1830, 2030, 2130, 2630, 2040, 2240, 2640, 2020, 2120, 2030, 2130, 2440, 2150, 2155, 2350, 2550, 2750, 2355, 2555, 2755, 300, 300B, 400, 301, 302, 401, 310, 410

R48595

Leveling Fork



Fits 820, 920, 1020, 1520, 830, 930, 1030, 1130, 1530, 1630, 1830, 2030, 2130, 2630, 2040, 2240, 2640, 2020, 2120, 2030, 2130, 2440, 2150, 2155, 2350, 2550, 2750, 2355, 2555, 2755, 300, 300B, 400, 301, 302, 401, 310

RE45632

Leveling Assembly



Fits 4500, 4600, 4700, 5200, 5300, 5400, 5500, 5210, 5310, 5410, 5510, 5220, 5320, 5420, 5520, 5403, 5105, 5205, 5615, 5715, 5225, 5325, 5425, 5625, 5725, 110 Tractor, 110 Loader

AR55695

Replaces T22714
Lift Arm Pin



Fits 820, 920, 1020, 1520, 830, 930, 1030, 1130, 1530, 1630, 1830, 2030, 2130, 2630, 2040, 2240, 2640, 2020, 2120, 2030, 2130, 2440, 2150, 2155, 2350, 2550, 2750, 2355, 2555, 2755, 300, 300B, 400, 301, 302, 401, 310

AT19850

Drawbar Pin



Fits 820, 920, 1020, 1120, 1520, 2020, 2120, 830, 930, 1030, 1130, 1530, 1630, 1830, 2030, 2130, 2630, 2040, 2240, 2440, 2640, 300B

T30276

Sway Block, R/H



T30277

Sway Block, L/H



AT20167

Sway Block Bracket, R/H



AT20168

Sway Block Bracket, L/H

Fits 820, 920, 1020, 1520, 830, 930, 1030, 1130, 1530, 1630, 1830, 2030, 2130, 2630, 2040, 2240, 2640, 2020, 2120, 2030, 2130, 2440, 2150, 2155, 2350, 2550, 2750, 2355, 2555, 2755, 300, 300B, 400, 301, 302, 401, 310

R39512

Sway Block, R/H



R39513

Sway Block, L/H



Fits 2510, 2520, 3020, 4000, 4020, 4030, 4040, 4050, 4055, 4230, 4240, 4250, 4255, 4320, 4430, 4455



TACH CABLES

John Deere



AL23837

Replaces AT19905

Tachometer Cable

Fits 820, 830, 920, 1020, 1120 All 3 Cylinders

AL23838

Replaces AT19904

Tachometer Cable

Fits 2020, 2030, 2130 All 4 Cylinders

John Deere

SHEET METAL

R52362

Nose Cone



Fits 2040, 2140, 2240, 2440, 2640, 2940, 3040, 3140

R59961

Nose Cone



Fits 830, 930, 1030, 1130, 1530, 1630, 1830, 2030, 2130, 2040, 2240, 2440, 2640

AT20026

Battery Door



Fits 820, 920, 1020, 1520, 830, 930, 1030, 1130, 1530, 1630, 1830, 2630, 2040, 2240, 2440, 2640, 2020, 2120, 2030, 2130, 2440, 300, 300B, 400, 301, 302, 401

AL31039

Battery Cover, R/H
Fiberglass
(For 4 Cylinder Tractors Only)



AL31040

Battery Cover, L/H
Fiberglass
(For 4 Cylinder Tractors Only)

Fits 1640, 1840, 2040S, 2140, 2350, 2440 S/N 341000>, 2550, 2640 S/N 341000>, 2750

T22209

Battery Panel, R/H



T22210

Battery Panel, L/H

Fit 2020, 2120, 1630, 1830, 2030, 2130, 2020, 2120, 2030, 2130, 2440, 300, 300B, 400, 301, 302, 401
4 Cylinder Tractors

DE13523

Headlight Assy, R/H



DE13524

Headlight Assy, L/H

Fits 820, 920, 1020, 1520, 2020, 2120, 830, 930, 1030, 1130, 1530, 1630, 1830, 2030, 2130, 3120, 3030, 3130

R26858

Side Screen Spring



Fits 820, 920, 1020, 1120, 1520, 2020, 2120, 1530, 1630, 1830, 2030, 2130, 2630, 2040, 2240, 2440, 2640, 2150, 2155, 300, 300B, 400, 301, 302, 401, 310, 410



SHEET METAL

John Deere

AR72949

Grille Screen
13 3/4" x 17"
Bottom Mounting Holes
are 16 1/4" Center to Center



Fits 820, 920, 1020, 1520, 1630, 2020, 2120, 2040, 2240,
2150, 2155, 300, 300B, 400, 301, 302, 401

AR72950

Grille Screen
17" x 17"
Bottom Mounting Holes are 16 1/4" Center to Center

Fits 1830, 2630, 2640, 2020, 2120, 2030, 2130, 2440,
300, 300B, 400, 301, 302, 401, 310, 410

AL31253

Grille Screen
17" x 17"
Bottom Mounting Holes are 12" Center to Center

Fits 940, 1040, 1140, 2040, 2240

AL31252

Grille Screen
17" x 17"
Uses Clips Instead of Mounting Holes

Fits 1640, 1840, 2040, 2040S, 2140

AL31251

Grille Side Screen
17" x 19 1/2"
Uses Clips Instead of Mounting Holes

Fits 2040S, 2140

AR26849

Side Screen
19 1/8" x 18 1/4"
Fits 3010, 3020

AR32720

Side Screen
20 1/8" x 17"
Fits 4000, 4010, 4020

AR26494

Top Grille



Fits 3010, 3020

AR26770

Side Shield, L/H



AR26769

Side Shield, R/H

Fits 4010, 4020 S/N <200999

AR77326

Replaces **AR28277,**
AR34990, AT16288,
AT416918

Rear Combination Light



Fits 50, 60, 70, 80, 520, 530, 620, 630, 720, 730, 820, 830,
920, 930, 1010, 1020, 1040, 1120, 1130, 1140, 1520, 1530,
1630, 1640, 1750, 1830, 1840, 1850, 2010, 2020, 2030,
2040, 2120, 2130, 2150, 2240, 2255, 2350, 2355, 2355N,
2440, 2510, 2520, 2550, 2555, 2630, 2640, 2650, 2750,
2755, 2840, 2850, 2855, 2855N, 2940, 2950, 2955, 3010,
3020, 3030, 3130, 3140, 4000, 4010, 4020, 4320, 4520,
4620, 5010, 5020, 6030, 00B, 301A, 302, 302A, 340D,
380, 401B, 401C, 401D, 440, 440A, 440B, 440C, 440D,
448D, 480, 480C, 500A, 500C, 510, 540, 540A, 540B,
540D, 600, 640, 640D, 648D, 700A, 740, 740A, 760A



Call Us: 1 (800) 462-7335

John Deere

SHEET METAL

AT20777

Replaces **AT27146**
Shell Fender, R/H



AR51407

Replaces **AR51408**
Shell Fender, L/H

Fit 820, 920, 1020, 1520, 830, 930, 1030, 1130, 1530, 1630, 1830, 2030, 2130, 2630, 2040, 2240, 2440, 2640, 2150, 2350, 2550, 2750, 2155, 2355, 2555, 2755, 300, 300B, 400, 301, 302, 401

R70588

Fender Bracket
For Flat Top Fender



Fits 2010, 1830, 2030, 2130, 2630, 2040, 2240, 2440, 2640, 2020, 2120, 2030, 2130, 2440, 3120, 3030, 3130, 2840, 2940, 2950, 3040, 2855, 2955, 3055, 3155, 3255, 2350, 2550, 2750, 2355, 2555, 2755, 2510, 2520, 3010, 4010 3020, 4020, 4000

AL113571

Replaces **AL154911**,
AL155038, **AL82366**
Step Assembly



Fits 6010, 6020, 6110, 6120, 6210, 6215, 6220, 6230, 6310, 6320, 6330, 6405, 6410, 6415, 6420, 6430



SEATS

John Deere

PJ-11

Yellow Seat
With Slide Track



PA-11

Black Seat
With Slide Track



BT-116B

Black Seat
With Slide Track



BT-116Y

Yellow Seat
With Slide Track
Without Arm Rests



Fits Most John Deere Tractors

AL173569

Replaces AL119958
Buddy Seat



Fits 6105M, 6115M, 6125M, 6130, 6130M, 6140M, 6150M, 6170M, 6230, 6330, 6415, 6430, 6530, 7130, 7210, 7220, 7230, 7320, 7330, 7410, 7420, 7430, 7510, 7520, 7530, 7600, 7610, 7700, 7710, 7800, 7810

John Deere

WHEELS & RIMS

WHEEL01

Replaces **AL17850, JD3039**

Front Wheel 4.5" x 16"
For a 6.00" x 16" Tire



WHEEL02

Replaces **AR52506, AL17847, JD3002, AL68227, JD3041**

Front Wheel 5.5" x 16"
For a 7.50" x 16" Tire



Fits 820, 920, 1020, 1520, 830, 930, 1030, 1130, 1530, 1630, 1830, 2030, 2130, 2630, 2040, 2240, 2640, 2020, 2120, 2440, 2150, 2155, 2350, 2550, 2750, 2355, 2555, 2755, 300, 300B, 400, 301, 302, 401, 310, 410, 2510, 2520, 3010, 4010, 3020, 4020, 4320, 4030, 4230, 4040, 4240, 4430

WHEEL26

Replaces **JD3210, AL82490**

Front Wheel
8.00" x 16" Tire



Fits 2350, 2550, 2750, 2950, 2355, 2555, 2755, 2955, 2840, 2940, 3040, 3140, 3010, 4010, 3020, 4020, 4320, 4040, 4240

WEIGHT01

Front Wheel Weight



Fits Most 16" Front Rims

WHEEL03

Replaces **AT17346**

Rear Rim 10" x 28"
6 Loop

WHEEL04

Replaces **T21741, AL16602**

Rear Rim 11" x 28"
6 Loop



WHEEL05

Replaces **T21743, AL15368**

Rear Rim 12" x 28"
6 Loop

WHEEL19

Replaces **1861894M91, 373508R91, AL2452, AL36059, AL36059, AL63463**

Rear Rim 13" x 28"
6 Loop

WHEEL18

Rear Rim 14" x 30"
8 Loop

WHEEL30

Replaces **RE14008, AL57482, AL31533**

Rear Rim 15" x 30"
8 Loop



Fits 820, 920, 1020, 1520, 830, 930, 1030, 1130, 1530, 1630, 1830, 2030, 2130, 2630, 2040, 2240, 2640, 2020, 2120, 2440, 2150, 2155, 2350, 2550, 2750, 2355, 2555, 2755, 300, 300B, 400, 301, 302, 401

WHEELS & RIMS

John Deere

WHEEL29

Replaces T19065, L40667

Rear Wheel Center
For 28" Rim
Will also work on
30" Rims with
Drop Center



Fits 820, 920, 1020, 1520, 830, 930, 1030, 1130, 1530, 1630, 1830, 2030, 2130, 2630, 2040, 2240, 2640, 2020, 2120, 2440, 2150, 2155, 2350, 2550, 2750, 2355, 2555, 2755, 300, 300B, 400, 301, 302, 401

BOLTKIT01

Bolt & Nut, Fiat Style
2 1/2" Long



BOLTKIT02

Bolt & Nut, MF Style
3" Long



BOLTKIT03

Bolt & Nut, Ford Style
3" Long



BOLTKIT04

Bolt & Nut, JD Style
4 3/4" Long



WHEEL33

Replaces AL82531

Rear Rim 15" x 30"
For Square Type
Wheel Center

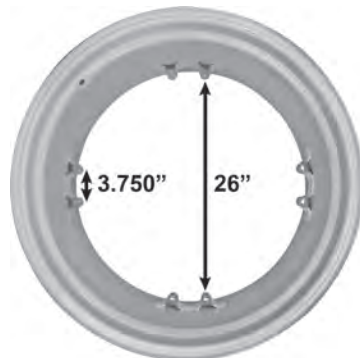

WHEEL35

Rear Wheel Center
30"

For Square Type Wheel

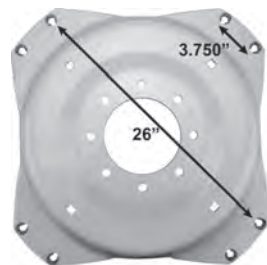

Fits 2150, 2350, 2550, 2750, 2155, 2355, 2755, 5200, 5300, 5400, 5500



John Deere

SHOP MANUALS



ITJD4

I&T JD-4 John Deere Shop Manual

Fits Series A (S/N 499000 & Up), B (S/N 96000 & Up), G (S/N 13000 & Up), H, Models D (S/N 143800 & Up), M, MT



ITJD10

I&T JD-10 John Deere Shop Manual

Fits Gasoline Models 50, 60, 70



ITJD16

I&T JD-16 John Deere Shop Manual

Fits 520, 530, 620, 630, 720, 730



ITJD21

I&T JD-21 John Deere Shop Manual

Fits Series 1010, 2010



ITJD37

I&T JD-37 John Deere Shop Manual

Fits Diesel Models: 1020, 1520, 1530, 2020, 2030; Gas Models: 1020, 1520, 2020, 2030



ITJD47

I&T JD-47 John Deere Shop Manual

Fits 850, 950, 1050



ITJD50

I&T JD-50 John Deere Shop Manual

Fits Diesel Models: 4030, 4230, 4430, 4630; Gas Models: 4030, 4230



ITJD56

I&T JD-56 John Deere Shop Manual

Fits 2840, 2940, 2950



ITJD57

I&T JD-57 John Deere Shop Manual

Fits 4050, 4250, 4450, 4650, 4850



ITJD58

I&T JD-58 John Deere Shop Manual

Fits Diesel Models 2150, 2155, 2255, 2350, 2355, 2355N, 2550, 2555



ITJD59

I&T JD-59 John Deere Shop Manual

Fits Diesel Models 2750, 2755, 2855N, 2955



ITJD60

I&T JD-60 John Deere Shop Manual

Fits Diesel Models: 4055, 4255, 4455, 4555, 4755, 4955



ITJD61

I&T JD-61 John Deere Shop Manual

Fits 655, 755, 756, 855, 856, 955



ITJD62

I&T JD-62 John Deere Shop Manual

Fits Diesel Models: 670, 770, 870, 970, 1070



ITJD201

I&T JD-201 John Deere Shop Manual

Fits Diesel Models: 80, 420, 430, 435D, 440 (S/N 448000 and Prior), 440ID, 720, 730, 820 (2 & 3-Cylinder), 830 (2 and 3-Cylinder); Gasoline Models: 40, 320, 330, 420, 430, 440 (S/N 448001 and Up)



ITJD202

I&T JD-202 John Deere Shop Manual

Fits Gasoline Models: 2510, 2520; Diesel Models: 2040, 2240, 2440, 2510, 2520, 2630, 2640, 4040, 4240, 4440, 4640, 4840



ITJD203

I&T JD-203 John Deere Shop Manual

Fits Gasoline Models: 3010, 3020, 4000, 4010, 4020; Diesel Models: 3010, 3020, 4000, 4010, 4020, 4320, 4520, 4620, 5010, 5020, 6030

