



www.CrossCreekTractor.com

Call Us: 1 (800) 462-7335

AFTERMARKET TRACTOR PARTS FOR

FORD NEW HOLLAND

**ALL PARTS LISTED ARE AFTERMARKET REPLACEMENT PARTS AND ARE NOT
PRODUCED BY THE ORIGINAL EQUIPMENT MANUFACTURER**



Contents - Ford / New Holland

Air Cleaners	74	Seats.....	108
Clutch.....	35	Sheet Metal.....	100
Cooling.....	59	Shop Manuals.....	109
Electrical	64	Steering, Add-On Kits	34
Engine, Crankshafts	11	Steering, Control Valves	25
Engine, Camshafts & Misc.....	12	Steering, P/S Cylinders.....	32
Engine, Rebuild Parts	4	Steering, P/S Cylinder Parts	33
Front Axle, Axle Parts	17	Steering, P/S Pumps	30
Front Axle, Hubs	17	Steering, P/S Tie Rod Ends	31
Front Axle, Spindles.....	15	Steering, Sectors	24
Front Axle, Supports	19	Steering, Sector Parts.....	26
Front Axle, Tie Rod Ends	20	Steering, Wheels	29
Fuel.....	75	Transmission, 4 Speed	40
Hitch.....	94	Transmission, 5 Speed	42
Hitch, Drawbars	97	Transmission, 6 & 8 Speed.....	43
Hitch, Stabilizers	96	Transmission, 6 Cylinder	48
Hydraulics, Hydraulic Pumps.....	83	Transmission, Dexta, S. Dexta	48
Hydraulics, Hydraulic Pump Parts .	85	Transmission, Dual Power.....	49
Hydraulics, Lift Cover.....	90	Transmission, New Holland	52
Hydraulics, Misc.....	92	Transmission, Shuttle	50
Manifolds & Mufflers	13	Wheels & Rims	106
PTO	53		
Rear Axle, Differential & Brakes	98		



Ford / New Holland

ENGINE, REBUILD PARTS

D6NN6108L
Replaces D4NN6108L
Piston, 4.2" STD

D6NN6108N
Replaces D4NN6108N
Piston, 4.2" .020

D6NN6108P
Replaces D4NN6108R
Piston, 4.2" .030

D6NN6108R
Replaces D4NN6108S
Piston, 4.2" .040

A: 2.770" Compression Height
B: 1.50" Pin Diameter

C7NN6108S
Piston, 4.2" STD

C5NN6108R
Piston, 4.2" .020

C5NN6108S
Piston, 4.2" .030

A: 2.970" Compression Height
B: 1.50" Pin Diameter

D4NN6108AA
Replaces E1NN6108LA
Piston, 4.4" STD

D4NN6108AC
Replaces E1NN6108NA
Piston, 4.4" .020

D4NN6108AD
Replaces E1NN6108PA
Piston, 4.4" .030

D4NN6108AE
Replaces E1NN6108SA
Piston, 4.4" .040

A: 2.785" Compression Height
B: 1.50" Pin Diameter

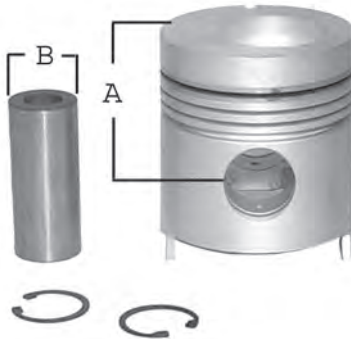

**ORDERING
FORD PISTONS MADE EASY**

Due to the fact that over the years engines have been replaced in many tractors, you can't count on ordering pistons by the tractor model number or year.

We have simplified the ordering process.

~Determine the diameter of the piston you are in need of, 4.2" or 4.4".

~Determine the size you need, standard bore size or over sized.

~ Measure the distance from the center of the pin hole to the top of the piston (see diagram) to find the value of A.

~Measure the pin diameter to find the value of B (see diagram).

~Choose the piston that matches your findings.

E0NN6108AA
Replaces D2NN6108AC
Piston, 4.4" STD

E0NN6108AC
Replaces D2NN6108AE
Piston, 4.4" .020

E0NN6108AD
Replaces D2NN6108AF
Piston, 4.4" .030

E0NN6108AE
Replaces D2NN6108AG
Piston, 4.4" .040

A: 2.690" Compression Height
B: 1.50" Pin Diameter

D9NN6108FA
Piston, 4.4" Turbo STD

D9NN6108HA
Piston, 4.4" Turbo .020

D9NN6108JA
Piston, 4.4" Turbo .030

D9NN6108KA
Piston, 4.4" Turbo .040

A: 2.673" Compression Height
B: 1.625" Pin Diameter

D6NN6108Y
Piston, 4.4" Turbo STD

D6NN6108AA
Piston, 4.4" Turbo .020

D6NN6108AB
Piston, 4.4" Turbo .030

D6NN6108AC
Piston, 4.4" Turbo .040

A: 2.778" Compression Height
B: 1.625" Pin Diameter



ENGINE, REBUILD PARTS

Ford / New Holland



RING SETS FOR NON-TURBOCHARGED ENGINES
Order One Set For Each Piston

DJPN6149S
Ring Set, 4.2" STD

DJPN6149W
Ring Set, 4.4" STD

DJPN6149T
Ring Set, 4.2" .020

DJPN6149X
Ring Set, 4.4" .020

DJPN6149U
Ring Set, 4.2" .030

DJPN6149Y
Ring Set, 4.4" .030

DJPN6149V
Ring Set, 4.2" .040

DJPN6149Z
Ring Set, 4.4" .040

RING SETS FOR TURBOCHARGED ENGINES
Order One Set For Each Piston

DJPN6149E
Ring Set, 4.4" Turbo STD

DJPN6149C
Ring Set, 4.4" Turbo .030

DJPN6149B
Ring Set, 4.4" Turbo .020

DJPN6149D
Ring Set, 4.4" Turbo .040

C5NN6507B

Intake Valve STD
3 and 4 Cylinder

C7NN6505B

Exhaust Valve STD
3 and 4 Cylinder

Fits 2000, 3000, 4000, 5000

D3NN6507A

Intake Valve STD
3 and 4 Cylinder

D3NN6505A

Exhaust Valve STD
3 and 4 Cylinder

Fits 2600, 3600, 4600, 5600, 6600, 231, 335, 531, 5610, 6610

D8NN6507AB

Intake Valve STD
3 and 4 Cylinder

D8NN6505AA

Exhaust Valve STD
3 and 4 Cylinder

Fits 7000, 7100, 7200, 7600, 7700, 7610



C5NN6055A

Replaces 81815327
4.2", Semi Finished Sleeve

D7NN6055A

Replaces 83912946
4.4", Semi Finished Sleeve



Fits 2000, 3000, 4000, 5000, 2600, 3600, 4600, 5600, 6600, 7000, 7100, 7200, 7600, 7700, 2310, 2610, 2810, 2910, 3610, 3910, 4610, 5610, 6610, 7610

Ford / New Holland

ENGINE, REBUILD PARTS



C7NN6051R
Cylinder Head Gasket
4.2", 3 Cylinder

Fits 2000, 3000, 3400,
3500

C7NN6051S
Cylinder Head Gasket
4.4", 3 Cylinder

Fits 4000, 4500

D3NN6051E
Cylinder Head Gasket
4.2", 3 Cylinder

Fits 2600, 3600, 231, 335

E0NN6051AA
Replaces 87800106,
D8NN6051AA
Cylinder Head Gasket
4.4", 3 Cylinder

Fits 4000, 4600, 445, 531

C7NN6584B

Valve Cover Gasket
All 3 Cylinder



Fits 2000, 3000, 4000, 4000SU, 2600, 3600, 4600,
4600SU, 2310, 2610, 2810, 2910, 3610, 3910, 4610, 231,
335, 531, 340, 540, 3400, 3500, 445, 4500

D0NN6710B

Oil Pan Gasket
All 3 Cylinder



Fits 2000, 3000, 4000, 4000SU, 2600, 3600, 4600,
4600SU, 2310, 2610, 2810, 2910, 3610, 3910, 4610, 231,
335, 531, 340, 540, 3400, 3500, 445, 4500

CFPN6008B

Top Gasket Set
Without Head Gasket
All 3 Cylinder

Fits 2000, 3000, 4000,
4000SU, 2600, 3600, 4600,
4600SU, 2310, 2610, 2810,
2910, 3610, 3910, 4610, 231,
335, 531, 340, 540, 3400, 3500, 445, 4500

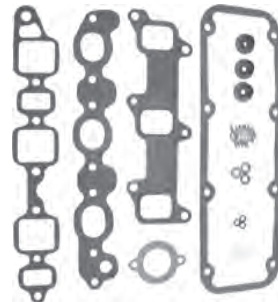

CFPN6A008B

Replaces EAPN6A008A
Bottom Gasket Set
With Crankshaft Seals
All 3 Cylinder

Fits 2000, 3000,
4000, 4000SU,
2600, 3600, 4600,
4600SU, 2310,
2610, 2810, 2910,
3610, 3910, 4610,
231, 335, 531, 340, 540, 3400, 3500, 445, 4500



C5NE6020A

Front Timing
Cover Gasket
3 and 4 Cylinder



C5NE6C045A

Rear Timing Plate Gasket
3 and 4 Cylinder

Fits 2000, 3000, 4000, 4000SU, 2600, 3600, 4600,
4600SU, 5000, 5100, 5200, 7000, 7100, 7200, 5600, 6600,
7600, 6700, 7700, 5610, 6610, 7610, 6710, 7710, 5600,
6600, 7600, 2310, 2610, 2810, 2910, 3610, 3910, 4610,
231, 335, 531, 340, 540, 3400, 3500, 445, 4500



Call Us: 1 (800) 462-7335

ENGINE, REBUILD PARTS

Ford / New Holland



C7NN6051T
Replaces D3NN6051F
Cylinder Head Gasket
4.2", 4 Cylinder

Fits 5000, 5100, 5200,
5600, 5610

F1NN6051BA
Cylinder Head Gasket
4.4", 4 Cylinder

Fits 7000, 7100, 7200, 6600,
7600, 7700, 6610, 6710, 7710

C7NN6584C
Valve Cover Gasket
All 4 Cylinder



Fits 5000, 5100, 5200, 7000, 7100, 7200, 5600, 6600,
7600, 6700, 7700, 5610, 6610, 7610, 6710, 7710

CFPN6008C
Top Gasket Set
Without Head Gasket
All 4 Cylinder

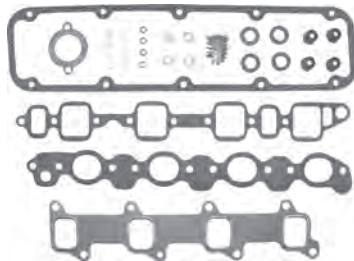

Fits 5000, 5100, 5200, 7000, 7100, 7200, 5600, 6600,
7600, 6700, 7700, 5610, 6610, 7610, 6710, 7710

D0NN6710D
Oil Pan Gasket
All 4 Cylinder



Fits 5000, 5100, 5200, 7000, 7100, 7200, 5600, 6600,
7600, 6700, 7700, 5610, 6610, 7610, 6710, 7710

CFPN6A008C
Bottom Gasket Set With Crankshaft Seals
All 4 Cylinder



Fits 5000, 5100, 5200, 7000, 7100, 7200, 5600, 6600,
7600, 6700, 7700, 5610, 6610, 7610, 6710, 7710

C5NE6020A
Front Timing
Cover Gasket
3 and 4 Cylinder



C5NE6C045A
Rear Timing
Plate Gasket
3 and 4 Cylinder



Fits 2000, 3000, 4000, 4000SU,
2600, 3600, 4600, 4600SU, 5000,
5100, 5200, 7000, 7100, 7200, 5600,
6600, 7600, 6700, 7700, 5610, 6610, 7610, 6710, 7710,
5600, 6600, 7600, 2310, 2610, 2810, 2910, 3610, 3910,
4610, 231, 335, 531, 340, 540, 3400, 3500, 445, 4500

C5NE6207A
Connecting Rod Bushing



C5NE6261B
Camshaft Bushing



Fits 2000, 3000, 4000, 4000SU, 2600, 3600, 4600, 4600SU, 5600, 6600, 7600, 2310, 2610, 2810, 2910, 3610, 3910, 4610,
5000, 5100, 5200, 7000, 7100, 7200, 5600, 6600, 7600, 5610, 6610, 7610, 340, 540, 3400, 3500, 445, 4500, 8000, 9000,
8600, 9600



Ford / New Holland

ENGINE, REBUILD PARTS

B3047SASTD

Rod Bearing Set, 3 Cyl STD

B3047SA010

Rod Bearing Set, 3 Cyl .010

B3047SA020

Rod Bearing Set, 3 Cyl .020

B3047SA030

Rod Bearing Set, 3 Cyl .030



M4218SASTD

Main Bearing, Set 3 Cyl STD

M4218SA010

Main Bearing Set, 3 Cyl .010

M4218SA020

Main Bearing Set, 3 Cyl .020

M4218SA030

Main Bearing Set, 3 Cyl .030



Fits 3 Cylinder Tractors 2000, 3000, 4000, 2600, 3600, 4600, 2310, 2610, 2910, 3610, 3910, 4610, 3400, 3500, 445, 455

B4449SASTD

Rod Bearing Set, 4 Cyl STD

B4449SA010

Rod Bearing Set, 4 Cyl .010

B4449SA020

Rod Bearing Set, 4 Cyl .020

B4449SA030

Rod Bearing Set, 4 Cyl .030



Fits 4 Cylinder Tractors (Non-Turbo) 5000, 5600, 6600, 5610, 6610

M5224SASTD

Main Bearing Set, 4 Cyl STD

M5224SA010

Main Bearing Set, 4 Cyl .010

M5224SA020

Main Bearing Set, 4 Cyl .020

M5224SA030

Main Bearing Set, 4 Cyl .030



Fits 4 Cylinder Tractors 5000, 7000, 5600, 6600, 7600, 7700, 5610, 6610, 7610, 7710

E1NN6600DC

Replaces **E1NN6600DA**,
E1NN6600DB

Oil Pump
Non-Turbo



Fits 2000, 3000, 4000, 4000SU, 2600, 3600, 4600, 4600SU, 5000, 5100, 5200, 7000, 7100, 7200, 5600, 6600, 7600, 6700, 7700, 5610, 6610, 7610, 6710, 7710, 2310, 2610, 2810, 2910, 3610, 3910, 4610, 231, 335, 531, 340, 540, 3400, 3500, 445, 4500

E1NN6600CC

Oil Pump

Fits 6610, 6710, 7600, 7610, 7700, 7710, 4630 (6/1994 and Up), 5030 (10/1992 and Up)

8N6615

Replaces **86604201**
Oil Pump Pickup Tube



Fits 9N, 2N, 8N

957E6384B

Flywheel Ring Gear

Fits Dexta and Super Dexta



E2NN6384AA

Replaces **C5NE6384A**

Flywheel Ring Gear
128 Teeth
16.115" O.D.
14.520" I.D.



Fits 2000, 3000, 4000, 5000, 7000, 2600, 3600, 4600, 5600, 5700, 6600, 6700, 7600, 7700, 2610, 2910, 3610, 2910, 4610, 5610, 6610, 7610, 7710, 8000, 9000, TW5, TW10, TW15, TW20, TW25, TW35



ENGINE, REBUILD PARTS

Ford / New Holland

F2NN6200BA

Replaces 82849195, 83958631, 83972114, E5HN6200CB, E9NN6200AB, E9NN6200CA
Connecting Rod

For Non-Turbocharged Engines With 1.500" Piston Pin. Bushing End Is Straight, Not Tapered



87801218

Replaces 81875622, 83991676, 83998932, 8781260, E9NN6200AD
Connecting Rod

For Non-Turbocharged Engine With 1.500" Piston Pin. Bushing End Is Tapered



Fits 2000, 3000, 4000, 4000SU, 2600, 3600, 4600, 4600SU, 5000, 5100, 5200, 5600, 6600, 6700, 5610, 6610, 6710, 5600, 6600, 2310, 2610, 2810, 2910, 3610, 3910, 4610, 3230, 3430, 3930, 4130, 4630, 4830, 5030, TS 80, TS90E, TS110, TS115, TM115, 231, 233, 335, 531, 340, 540, 3400, 3500, 445, 4500, L865, L783, AND L785,550, 555, 555A, 555B, 655A, 450, 540, 650, 345C, 445C, 545C, 555C, 655C, A64, 340A, 340B, 345D, 3550, 420, 445, 445A, 455C, 445D, 4500, 455, 515, 535, 540A, 540B, 545, 545A, 545D, 655, 555E, 655E, 455D, 555D, 575D, 655D, 675D, LB75.B, 6500, LB85, LB95, TS90, 250C, 234, TS90E, TB120, 230A, TB90, TB80, TB85, 4130H, BSD442, BSD444, BSD666, BSD333, BSD333H, BSD444, BSD332, M111 7.8L 188 HP, M121 7.8L 188 HP, M311 7.8L 220 HP, M321 7.8L 220 HP, M411 7.8L 240 HP, M421 7.8L 240 HP, M721 6.6L 143 HP, LS190, LX985, LS180, LX865, LX885

87801220

Replaces 81819490, 81864273, 81875652, 83947560, 83955929, 83959784, 83973859, 87770983, C9NN6200C, E4HN6200AC, E4NN6200BA, E4NN6200BB, E8NN6200AA, E9NN6200DA, F2NN6200EA
Connecting Rod

For Turbo-Charged Engines with 1.625" Piston. Bushing End Is Tapered



Fits 7000, 7100, 7200, 7600, 7700, 7410, 7610, 7710, TW15, TW20, TW25, TW35, 9000, 9600, 9700, TW30, 7410, 7610, 8630, 8730, 8830, 9200, 276V, 9030E, 9030V, 276VII, 750, 755, 555C, 655C, A62, A66, 555D, 575D, 655D, 675D, 7500, 755A, 755B, BSD442, BSD666T, BSD666TI, BSD444HT, AND BSD444T7.8L 220 HP, M321 7.8L 220 HP, M411 7.8L 240 HP, M421 7.8L 240 HP, M721 6.6L 143 HP, LS190, LX985, LS180, LX865, LX885



Call Us: 1 (800) 462-7335

Ford / New Holland

ENGINE, REBUILD PARTS

D3NN6A311A

Replaces 83924287,
D9NN6A311AC,
D9NN6A311AD

Balancer
39 Teeth, 1/2" Wide Gears

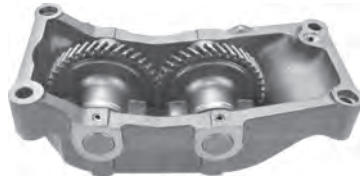

Fits 5000, 5100, 5200, 5340, 5610, 5110, 550, 555A, 555B, 555C, 555D, 5600, 5610, 5900, 650, 6500, 655A, 655C, 655D, 6610, 6700, 6710, 6810, 7410, 7500, 7600, 7610, 7700, 7710, A66 Used on Crankshaft C5NE6303K, C5NN6B303A, D9NN6B303AB, D9NN6B303AC, D3NN6B303A, C5NN6B302A, D9NN6B302AB, D9NN6B302AC, D3NN6B302A Housing C5NE6A308B

87802060

Replaces 81868467,
E9NN6A308AB, F0NN6B302AC,
F0NN6B303AC

Balancer



Fits 6640, 7740, 6610S, 7710S, 6640, 7010, TB100, TB110, TB90, TS90, TS100, LB110, LB115, B2550, HW300, HW320, LS190, LX985, LB75B, LB90 Gears are Marked F0NN6B302AC and F0NN6B303AC Housing is Marked E9NN6A308AB

F1NN6A311AA

Replaces 81873989, E3NN6A311AA,
E5NN6A311AA

Balancer
39 Teeth, 5/8" Wide Gears



Fits 4830, 5030, 5110, 550, 555, 555A, 555B, 555C, 555D, 5600, 5610, 575D, 5900, 650, 6500, 655A, 655C, 655D, 6610, 6700, 6710, 675D, 6810, 7410, 750, 7500, 755A, 755B, 7600, 7610, 7700, 7710, A66 Used on Crankshaft E5NN6B303AA and E5NN6B302AA Housing D9NN6A308AE



ENGINE, CRANKSHAFTS

Ford / New Holland

CRANKSHAFT40

Replaces D4JL6300B, D1NL6303D, D1NN6300B, C0NN6303J

Crankshaft, Ford 134-172
For Gas Tractors and Diesel Tractors Without Balancer Gear



Fits NAA, 600, 700, 800, 900, 601, 701, 801, 901, 2000-4000 4 Cylinder

CRANKSHAFT32

Replaces C5NE6303N, F0NN6300MA, F0NN6303MA

Crankshaft, Ford 201
(Confirm Stroke Before Ordering)
4.4" Stroke
3 Cylinder



Fits 4000, 4600, 4610, 340, 540, 445, 4500

CRANKSHAFT41

Replaces B9NN6303B, E2JL6300BA

Crankshaft, Ford 134-172
For Diesel Tractors with Balancer Gear



Fits 600, 700, 800, 900, 601, 701, 801, 901, 2000-4000 4 Cylinder

CRANKSHAFT36

Replaces C5NE6303K

Crankshaft, Ford 233-256
(Confirm Stroke Before Ordering)
4.2" Stroke, 78 Teeth
4 Cylinder



Fits 5000, 5100, 5200, 7000, 7100, 7200, 5600, 6600, 7600, 6700, 7700, 5610, 6610, 7610, 6710, 7710

CRANKSHAFT01

Replaces 957E6303B, E2006T9

Crankshaft, Perkins 3 Cylinder



Fits Ford Dexta, Super Dexta

CRANKSHAFT08

Replaces D9NN6303AA

Crankshaft, Ford 256-268
(Confirm Stroke Before Ordering)
4.4" Stroke, 76 Teeth
4 Cylinder



Fits 5000, 5100, 5200, 7000, 7100, 7200, 5600, 6600, 7600, 6700, 7700, 5610, 6610, 7610, 6710, 7710

CRANKSHAFT55

Replaces C5NE6303M, F0NN6300PA

Crankshaft, Ford 158
(Confirm Stroke Before Ordering)
3.8" Stroke
3 Cylinder



Fits 2000, 3000, 2600, 3600, 2310, 2610, 2910, 3610, 3910, 3400, 3500

CRANKSHAFT31

Replaces C5NE6303L, C5NE6303R

Crankshaft, Ford 175
(Confirm Stroke Before Ordering)
4.2" Stroke
3 Cylinder



Fits 2000, 3000, 2600, 3600, 2310, 2610, 2910, 3610, 3910, 3400, 3500

CRANKSHAFT37

Crankshaft, Ford 256-268
(Confirm Stroke Before Ordering)
4.4" Stroke, 78 Teeth
4 Cylinder



Fits 5000, 5100, 5200, 7000, 7100, 7200, 5600, 6600, 7600, 6700, 7700, 5610, 6610, 7610, 6710, 7710

Ford / New Holland

ENGINE, CAMSHAFTS & MISC

E8NN6250AA

Replaces **C7NN6250E, 87800323**

Camshaft For 3 Cylinder Gas Or Diesel Engines



Fits 2000, 3000, 4000, 2600, 3600, 4600, 2610, 2910, 3610, 3910, 4110, 4610, 3400, 3500, 3550, 4400, 4500, 335, 340, 420, 515, 532, 535, 540, 545A, 545B, 550, 555, 555A, 555B

E6TN6250AA

Replaces **C7NN6250B, E1TN6250AA**

Camshaft For 4 Cylinder Gas Or Diesel Engines



Fits 5000, 5100, 5200, 7000, 7100, 7200, 5600, 6600, 6700, 7600, 5610, 6610, 6710, 7610, 7710, 5900, 5500, 555C, 555D, 575D, 650, 6500, 655, 655A, 655C, 655D, 675D, 750, 7500, 755, 755A, 755B, BSD444, BSD444T BSD444H, BSD442

E3NN6250AC

Replaces **E3NN6250AB, D0NN6250A, C7NN6250C, 87802904, E1NN6250AC**

Camshaft For 6 Cylinder Gas Diesel Engines



Fits 8000, 9000, 8600, 9600, TW10, TW20, TW30 BSD666, BSD666T, BSD666TI

C7NN6500B

Replaces **81818724, 83946434, C5NE6500C**

Lifter

Fits Most Fords 1965 Up



D5NN6N609A

Replaces **83907851**

Oil Filler Cap

Fits Ford 1965 Up



C9NN6675A

Oil Pan

Stamped Steel

All 3 Cylinder



Fits 2000, 3000, 4000, 4000SU, 2600, 3600, 4600, 4600SU, 2310, 2610, 2810, 2910, 3610, 3910, 4610, 231, 335, 531, 340, 540, 3400, 3500, 445, 4500

309825

Adapter Set

For Spin-On Filter



Fits 2000, 3000, 4000, 4000SU, 5000, 5100, 5200, 7000, 7100, 7200, 3400, 3500, 445

E8NN6714AA

Replaces **D8NN6714BA, D8NN6714GA, E8NN6714BA**

Oil Filter, Spin-On Type



Fits 2000, 3000, 4000, 4000SU, 2600, 3600, 4600, 4600SU, 5000, 5100, 5200, 7000, 7100, 7200, 5600, 6600, 7600, 6700, 7700, 5610, 6610, 7610, 6710, 7710, 2310, 2610, 2810, 2910, 3610, 3910, 4610, 231, 335, 531, 340, 540, 3400, 3500, 445, 4500

DBPN6731A

Replaces **CFPN6731B, DBPN6731A**

Oil Filter, Cartridge Type



Fits 2000, 3000, 4000, 4000SU, 5000, 5100, 5200, 7000, 7100, 7200, 3400, 3500, 4500

D1NN9278B

Replaces **F1NN9278AA, D8NN9278BD, D8NN9278BC, D8NN9278BB, D8NN9278BA, C8NF9278B, 500630, F0NN9278AA**

Oil Pressure Sender



Fits 2000, 3000, 4000, 5000, 7000, 2600, 3600, 4600, 5600, 6600, 7600, 7700, 2310, 2910, 3610, 4610, 5610, 6610, 7610, 7710, 7810, 7910, 8210, TW15, TW25, TW35, TW5, 8000, 9000



MANIFOLDS & MUFFLERS

Ford / New Holland

9N9425

Manifold
Intake and Exhaust



Fits 2N, 8N, 9N

B9NN9425A

Replaces
EAE9425C, 312556
Manifold Intake and Exhaust



Fits NAA, 600, 700, 800, 900, 601, 701, 801, 901,
2000-4000 4 Cylinder Gas

957E9430B

Manifold Horizontal Exhaust



Fits Dexta, Super Dexta

957E9430A

Manifold Vertical Exhaust



Fits Dexta, Super Dexta

C5NE9430A

Manifold Horizontal Exhaust



Fits 2000, 3000, 4000, 4000SU, 3400, 3500, 4500

C5NE9430E

Manifold Vertical Exhaust



Fits 2000, 3000, 4000, 4000SU, 3400, 3500, 4500

C5NE9430D

Manifold
Vertical Exhaust



Fits 5000

D6NN5246N

Vertical Exhaust Elbow



E0NN5C250BA

Gasket

D3NN9430A

Manifold Vertical Exhaust



Fits 2600, 3600, 4600SU, 2310, 2610, 2810, 2910, 3610,
3910, 4610, 231, 335, 531, 340, 540, 445

D3NN9430B

Replaces 81837151

Manifold
Vertical Exhaust



Fits 5600, 6600, 5610, 6610

E0NN5246AA12B

Replaces 83946843

Vertical Exhaust Elbow
4 Cylinder
4 Bolt Flange



Fits 5610, 6610

E3NN5246BA

Exhaust Elbow
For Turbocharged Engines



Fits 7610, 750, 755, 755A, 755B



Call Us: 1 (800) 462-7335

Ford / New Holland

MANIFOLDS & MUFFLERS

C5NE9448A

Exhaust Manifold Gasket
All 3 Cylinder



Fits 2000, 3000, 4000, 4000SU, 2600, 3600, 4600SU
2310, 2610, 2810, 2910, 3610, 3910, 4610, 231, 335,
531, 340, 540, 3400, 3500, 445, 4500

C5NE9448B

Exhaust Manifold
Gasket, All 4 Cylinder



Fits 5000, 5100, 5200, 7000, 7100, 7200, 5600, 6600,
7600, 6700, 7700, 5610, 6610, 7610, 6710, 7710

C7NN5230R

Muffler and Pipe



Fits 2000, 3000, 4000, 5000, 3400, 3500, 4400, 4500

FRONT AXLE, SPINDLES

Ford / New Holland

2N3105

Replaces 2N3105AA
Spindle, R/H

A - 11.000"
B - 1.250"
C - 1.250"
D - 1.187"
E - .750"

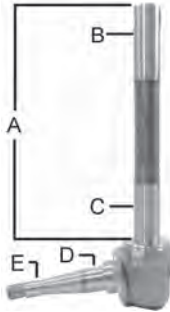

2N3106

Replaces 2N3106AA
Spindle, L/H

Fits 2N, 9N

E0NN3105AA

Spindle, R/H
Keyed at 7:00

A - 11.750"
B - 1.246"
C - 1.464"
D - 1.375"
E - .750"

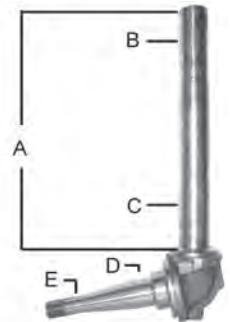

E0NN3106AA

Spindle, L/H
Keyed at 5:00

Fits 2310, 2610, 2910, 3610,
3910, 4610, 4610SU

8N3105

Replaces 8N3105B
Spindle, R/H

A - 10.750"
B - 1.250"
C - 1.250"
D - 1.187"
E - .750"

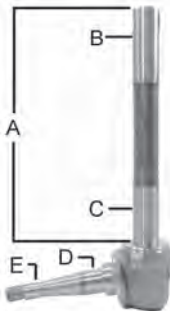

8N3106

Replaces 8N3106B
Spindle, L/H

Fits 8N, NAA

C5NN3105T

Spindle, R/H

A - 12.125"
B - 1.244"
C - 1.465"
D - 1.375"
E - .750"

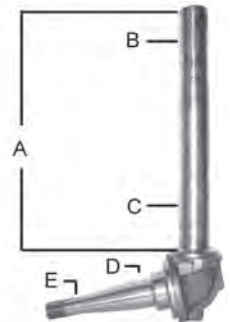

C5NN3106N

Spindle, L/H

Fits 4000

NCA3105B

Spindle, R/H

A - 10.687"
B - 1.250"
C - 1.340"
D - 1.250"
E - .750"

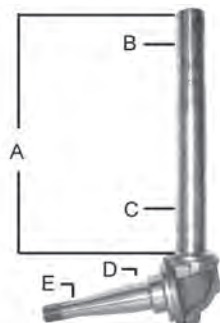

NCA3106B

Spindle, L/H

Fits, 600, 800, 601, 801, 2000-4000
4 Cylinder

D4NN3105A

Spindle, R/H

A - 12.250"
B - 1.464"
C - 1.464"
D - 1.375"
E - .750"

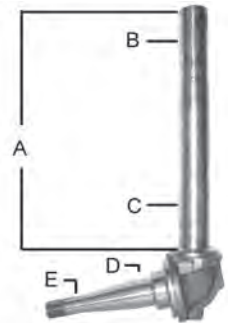

D4NN3106A

Spindle, L/H

Fits 4600-4610

C5NN3105U

Spindle, R/H

A - 11.687"
B - 1.250"
C - 1.340"
D - 1.250"
E - .750"

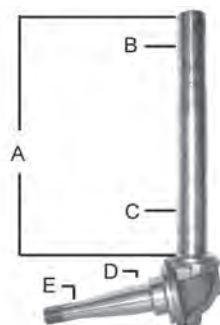

C5NN3106R

Spindle, L/H

Fits 2000, 3000, 2600, 3600

C5NN3105M

Spindle, R/H

A - 10.625"
B - 1.498"
C - 1.748"
D - 1.625"
E - .843"

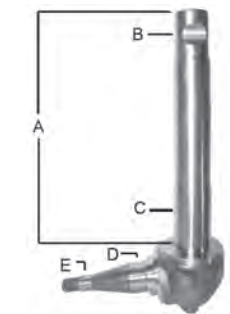

C5NN3106J

Spindle, L/H

Fits 5000, 5100, 5200, 7000, 7100,
7200, 5600, 6600, 7600, 5610,
6610, 7610

Ford / New Holland

FRONT AXLE, SPINDLES

D5NN3105F
Replaces 83908152,
877129943
 Spindle, R/H

A - 12.875"
 B - 1.722"
 C - 1.934"
 D - 1.625"
 E - .842"

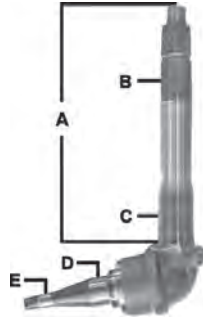

Fits 5700, 6700, 7700, 6710, 7710,
 7810, 8210

86566091
Replaces C5NN3105E
 Spindle
 1.13" King Pin



DEPN3115A
 King Pin Kit
 1.13" King Pin



Fits 1801, 4040, 4140; (1958-1985). 340, 340A, 340B, 420,
 445, 445A, 515, 535, 540, 540A, 550, 555, 555A, 555B,
 3500, 3550, 4400, 4500

D5NN3106F
Replaces 83908153,
87712937
 Spindle, L/H

A - 12.875"
 B - 1.722"
 C - 1.934"
 D - 1.625"
 E - .842"

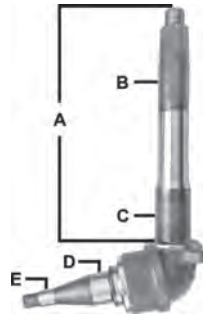

Fits 5700, 6700, 7700, 6710, 7710,
 7810, 7910, 8210

E9NN3105CB
 Spindle, R/H - L/H

A - 9.500"
 B - 1.722"
 C - 1.934"
 D - 1.625"
 E - .843"

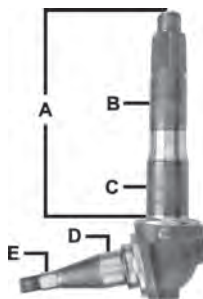

Fits 6640 Orchard, 7740 Orchard

86602834
Replaces E2NN3105BA
 Spindle
 1.23" King Pin



EFPN3115A
 King Pin Kit
 1.23" King Pin



Fits 250C, 260C, 340, 340A, 340B, 345C, 345D, 445,
 445A, 445C, 445D, 450, 455, 540, 540A, 540B, 545, 545A,
 545C, 545D

E9NN3105EB
 Spindle, R/H - L/H

A - 12.000"
 B - 1.722"
 C - 1.934"
 D - 1.625"
 E - .843"

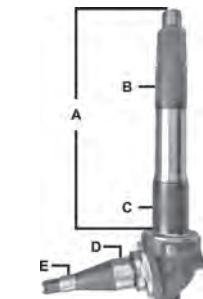

Fits 5640, 6640, 7740, 7840, TS90,
 TS100, TS100A, TS110, TS110A,
 TS115A, TS125A, TS130A, TS135A



FRONT AXLE, HUBS & AXLE PARTS

Ford / New Holland

C5NN3125A
Steering Arm Dust Seal



2N3109
Upper Spindle Bushing



Fits 8N, 9N, 2N, NAA, 600, 700, 800, 900, 601, 701, 801, 901, 2000-4000 4 Cylinder, 2000, 3000, 4000, 4000SU, 2600, 3600, 4600SU, 2310, 2610, 2810, 2910, 3610, 3910

NCA3110A
Lower Spindle Bushing



C0NN3123B
Spindle Thrust Bearing



Fits 8N, 9N, 2N, NAA, 600, 700, 800, 900, 601, 701, 801, 901, 2000-4000 4 Cylinder, 2000, 3000, 4000SU, 2600, 3600, 4600SU

C9NN1104F
Front Hub with Studs and Nuts



WBKFD04
Wheel Bearing Kit



Fits 501, 600, 700, 800, 900, Dexta, 2000, 3000, 2600, 3600, 2610, 2910, 3610, 3910

C9NN1104E
Front Hub with Studs and Nuts

WBKFD05
Wheel Bearing Kit

Fits 4000, 4600, 2310, 2610, 2910, 3610, 3910

C9NN1104D
Front Hub with Studs and Nuts

WBKFD06
Wheel Bearing Kit
Not for use with 10.00" x 16" tires

Fits 5000, 5100, 5200, 7000, 7100, 7200, 5600, 6600, 7600, 6700, 7700, 5610, 6610, 7610, 6710, 7710

387930S36
Replaces 354573S36
Spindle Hub Retaining Nut



957E1195
Tab Washer



C5NN1107F
Replaces 81816580
Front Wheel Bolt



C5NN1012B
Front Wheel Nut
Replaces 81815739



Fits 2000, 3000, 4000, 4000SU, 2600, 3600, 4600, 4600SU, 5000, 5100, 5200, 7000, 7100, 7200, 5600, 6600, 7600, 6700, 7700, 5610, 6610, 7610, 6710, 7710, 8000, 9000, 8600, 9600, 8700, 9700, TW5, TW10, TW15, TW20, TW25, TW30, TW35, 5600, 6600, 7600, 2310, 2610, 2810, 2910, 3610, 3910, 4610, 231, 335, 531, 340, 540, 3400, 3500, 445, 4500

D2NN3131A
Steering Arm, L/H
For Power Steering
1.244" Diameter Spindle
Shaft Opening
Fits 4000



D4NN3131C
Steering Arm, L/H
For Power Steering
1.464" Diameter Spindle
Shaft Opening
Fits 4600

D5NN3131B
Steering Arm
5700, 6700, 7700, 6710, 7710, 7810, 7910, 8210, 8700, 9700, TW10, TW20, TW30



D5NN3130B
Replaces 86533883
Steering Arm, R/H Side For
Tractors With Short Wheel
Base, 39 Splines



NEW ITEM

Fits 5700, 6700, 7700, 6710, 7710, 7810, 7910, 8210, 8700, 9700, TW10, TW20, TW30



Ford / New Holland

FRONT AXLE, AXLE PARTS

C7NN3010F

Center Axle with Bushing



C7NN3153B

Front Axle Bushing



Fits 2000, 3000, 4000SU, 2600, 3600, 4600SU, 2310, 2610, 2810, 2910, 3610, 3910, 4610, 231, 335, 531

C5NN3153A

Front Axle Bushing



Fits 5000, 5100, 7000, 7100, 5600, 6600, 7600, 5610, 6610, 7610, 8000, 9000, 8600, 9600, 9700, TW5, TW10, TW15, TW20, TW25, TW30, TW35, 3500, 4400

C5NN3127B

Front Axle Pin

Fits Early 2000, 3000, 4000SU



C7NN3127D

Replaces 81822711

Front Axle Pin
Manual and Power



C5NN3128B

Flange



Fits Late 2000, 3000, 4000SU, 2600, 3600, 4600SU, 2310, 2610, 2810, 2910, 3610, 3910, 4610, 231, 335, 531

C7NN3006J

Axle Knee, R/H
With Radius Rod
Pin Holes



C7NN3007J

Axle Knee, L/H
With Radius Rod
Pin Holes



For Spindles With 1.340" Lower Bushing Diameter

Fits 2000, 3000 Late Style, 2600, 3600, 4600SU, 2310, 2610, 2810, 2910, 3610, 3910, 4610, 231, 335, 531

E0NN3006BA

Axle Knee, R/H
With Larger Lower
Bushing



E0NN3007BA

Axle Knee, L/H
With Larger Lower
Bushing



For Spindles With 1.464" Lower Bushing Diameter

Fits 2600, 3600, 4600SU, 2310, 2610, 2810, 2910, 3610, 3910, 4610, 231, 335, 531

C5NN3N159A

Front Axle Pin, Front



C5NN3N160A

Front Axle Pin, Rear



Fits 5000, 7000, 5600, 6600, 7600, 5610, 6610, 7610, 5900, 3500, 3550, 4400, 515

C5NN3006A

Axle Knee, R/H



C5NN3007A

Axle Knee, L/H



Fits 5000, 7000, 5600, 6600, 7600, 5610, 6610, 7610

FRONT AXLE, AXLE PARTS & SUPPORTS

Ford / New Holland

C7NN3405B

Radius Rod, R/H for Power Steering
39 1/2" Long



C7NN3A292B

Radius Rod, L/H for Power Steering
39 1/2" Long

Fits 2000, 3000, 4000SU, 2600, 3600, 4600SU, 2310, 2610, 2810, 2910, 3610, 3910, 4610, 231, 335, 531

E0NN3N406BA

Replaces **C7NN3N406A**
Radius Rod Cap



E0NN3N442BA

Replaces **C5NN3N442C**
Radius Rod Socket



Fits 8N, 9N, 2N, NAA, 600, 800, 601, 801, 2000-4000 4 Cylinder, 2000, 3000, 4000, 4000SU, 2600, 3600, 4600, 4600SU, 2310, 2610, 2810, 2910, 3610, 3910, 4610

C5NN3N050B

Pivot Bracket
with Bushing



C5NN3A443A

Front Axle Bushing, Rear



C5NN3N052A

Front Axle Bushing, Front
For All Purpose Tractors

Fits 4000, 4600, 3910, 4610, 4630, 4830, 5030

D6NN3N670A

Center Steering Arm



C5NN3N703C

Pin for Steering Arm



C5NN3179B

Upper Bushing



C5NN3179A

Lower Bushing



Fits 5000, 5100, 7000, 7100, 5600, 6600, 7600, 5610, 6610, 7610

D3NN3A042D

Front Support



Fits 2000, 3000, 4000SU, 2600, 3600, 4600SU, 2310, 2610, 2810, 2910, 3610, 3910, 4610, 231, 335, 531

D0NN3029A

Replaces **E5NN3029BA**

Front Support
For tractors with P/S
after 9/1970



Fits 5000, 5100, 7000, 7100, 5600, 6600, 7600, 5610, 6610, 7610

Ford / New Holland

FRONT AXLE, TIE ROD ENDS

Measuring Tie Rods and Drag Links:

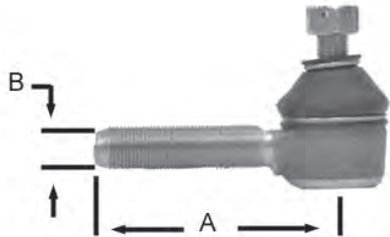

1939-1964 Tractors

8N3270

Drag Link End, Front

A - 3.375"
B - .687"
18 L/H thread

Fits 8N 48-52



NAA3270A

Drag Link End, Front

A - 3.875"
B - .687"
18 L/H thread

Fits 8N, NAA, 600, 800, 601, 801, 2000-4000 4 Cylinder

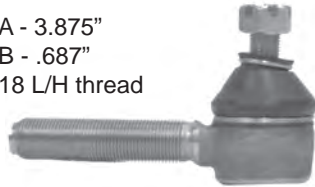

NAA33271A

Drag Link End, Rear

A - 4.250"
B - .687"
18 R/H thread

Fits 8N, NAA, 600, 800, 601, 801, 2000-4000 4 Cylinder



957E3287

Tie Rod Clamp
For 1.00" Shaft



Fits 8N, NAA, 500, 600, 700, 800, 900, 501, 601, 701, 801, 901, 2000-4000 4 Cylinder, 2000, 3000, 4000, 4000SU, 2600, 3600, 4600, 4600SU, 2310, 2610, 2810, 2910, 3610, 3910, 4610



C5NN3287C

Tie Rod Clamp
For 1.25" Shaft



Fits 5000, 5100, 5200, 7000, 7100, 7200, 5600, 6600, 7600, 5610, 6610, 7610

3000 Series Tractors 1/65-2/90

957E3290B

Drag Link End, Front
Manual Steering

A - 4.000"
B - .687" - 18 L/H thread



957E3307B

Drag Link End, Rear
Manual Steering

A - 4.500"
B - .687" - 18 R/H thread



C5NN3A300B

Drag Link End, Front
Power Steering

A - 3.312"
B - .750" - 16 L/H thread



C5NN3349A

Tie Rod Tube Link
With Clamps

A - 5.00"



C5NN3308E

Drag Link End, Rear L/H
Power Steering

Approx. 32.250"
long from center
of ball joint to end



C5NN3307G

Drag Link End, Rear R/H
Power Steering

Approx. 29.250"
long from center
of ball joint to end

Fits 2000, 3000, 2600, 3600, 4600SU, 2310, 2610, 2810, 2910, 3610, 3910, 4110, 4610SU, 230A, 231, 334, 335, 530A, 531

FRONT AXLE, TIE ROD ENDS

Ford / New Holland

4000 Series All Purpose Tractors

D0NN3A300A

Replaces C5NN3A300A
Front Drag Link End

A - 9.000"
B - .865"



Fits 4000 (1965-1975), 4600 (1975-1981)

C7NN3307A

Replaces 81821968
Rear Drag Link End

A - 40.000"



Fits 4000 Manual Steering (4/1970-1975), 4000 Power (8/1970-1971), 4600 Manual (1975-1981), 4610 Manual (1981 Up)

E1NN3A300AA

Front Drag Link End

A - 8.750"
B - .859"

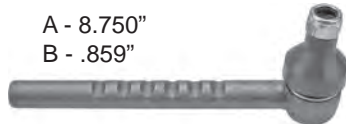

Manual or Power 8.75" to Center of Post
Fits 4610 (1981 Up), 4610

D0NN3307A

Rear Drag Link End

A - 41.500"



Fits 4000 (1972-1975), 4600 (1975-1981)

C5NN3278A

Long Tie Rod, Outer L/H

A - 19.000"
B - .750"



Fits 4000 R/H and L/H (1965-5/1967), L/H only (6/1967-1975), 4600 L/H (1975-1981), 4610 L/H (1981 Up)

C5NN3289C

Replaces 81815989
Short Tie Rod, Outer R/H

A - 3.750"
B - .750" - 16 thread



Fits 4000 (6/1967 Up), 4600, 4610

C5NN3283B

Tie Rod Tube
For All Purpose Tractors



Fits 4000 (6/1967 Up), 4600, 4610

5000 Series Tractors

C7NN3281A

Replaces C5NN3281B, 81822050
Long Tie Rod, Outer L/H

A - 15.375"
B - .937"

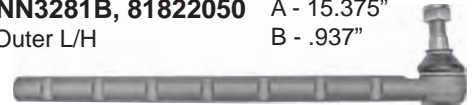

C7NN3280E

Replaces C5NN3280E, 81822049
Long Tie Rod, Outer R/H

A - 15.375"
B - .937"

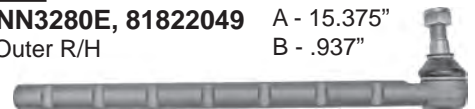

C7NN3B161A

Replaces 81822048
Long Tie Rod, Inner L/H

A - 18.125"



C7NN3289D

Replaces 81822051
Tie Rod End, Inner R/H

A - 3.750"
B - 1.000" - 16 thread



E3NN3307AA

Replaces C5NN3307F
Short Tie Rod



C7NN3B624B

Tie Rod Tube, R/H



TIEROD01

Tie Rod Assembly Complete, L/H



TIEROD02

Tie Rod Assembly Complete, R/H



E0NN3304CA

Replaces C7NN3304B, 83925158

Drag Link For Power Steering
50.50" Center of Post to Center of Post



All Fit 5000, 7000, 5600, 6600, 7600, 5610, 6610, 7610 (1981-3/1985)

Ford / New Holland

FRONT AXLE, TIE ROD ENDS

4 Cylinder 10 Series Tractors

E3NN3278AA

Replaces 83947645
Tie Rod End, R/H
(4/85-1/86)



E3NN3278AB

Replaces 83957771
Tie Rod Outer, R/H
(2/86-)

A - 17.750"
B - 1.250"



E3NN3289AA

Tie Rod End, L/H
(4/85-)

A - 5.000"



E3NN3N981AA

Replaces 83948964
Power Steering Cylinder End, L/H
(4/85-)

A - 2.875"
B - 1.250"
12 R/H thread



E3NN3B539AA

Replaces 83948951
Power Steering Cylinder End, R/H
(4/85-)

A - 3.625"
B - .875"
14 ID



Fits 5110, 5610, 5900, 6410, 6610, 6810, 7610

8000-9600 (1/68-7/76) Tractors

C7NN3280D

Tie Rod End, Outer R/H and L/H

A - 19.625"
B - .937"
9 notches
on bottom

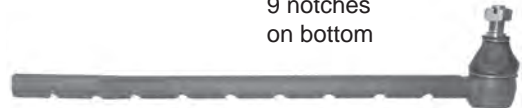

E3NN3307AA

Replaces C5NN3307F
Short Tie Rod
Used with C7NN3280D
Long Tie Rod

A - 3.812"
B - 1.000"
16 R/H thread



Fits 8000, 8200, 8400, 8600, 9000, 9200, 9600 all 68-76

Rowcrop Platform Tractor
4 and 6 Cylinder Models

E1NN3289AA

Replaces D5NN3289A
Short Tie Rod

A - 8.625"
B - 1.000"
16 R/H thread

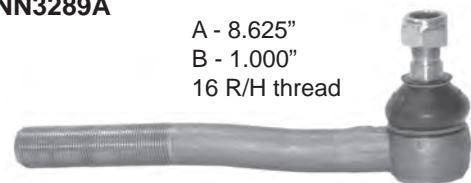

E1NN3280AA

Replaces D5NN3280A
Long Tie Rod

A - 33.062"
B - 1.187"
with 8 cross holes



Fits 5700, 6700, 6710, 7700, 7710, 7810, 7910, 8000, 8210, 8530, 8630, 8700, 8730, 8830, 9000, 9700, TW10, TW15, TW20, TW25, TW30, TW35, TW5

FRONT AXLE, TIE ROD ENDS

Ford / New Holland

ZF MFWD Tractors

ZP0501206190

Ball Joint and Tube, L/H



ZP0501206191

Ball Joint and Tube, R/H



ZP0501310060

Ball Joint and Rod



Fits 5110, 5610, 5900, 6410, 6710, 6810, 7410, 7610, 7710 (1/81-4/84)

ZP0501205463

Ball Joint and Tube, L/H



ZP0501205464

Ball Joint and Tube, R/H



ZP0750125014

Ball Joint and Rod



Fits 6710, 7610, 7710, 7910, 8210, TW5, TW15, TW25, (3/84-)

C5NN3A302B

Power Steering Cylinder End

Fits 2000, 2600, 3000, 3600, 4000SU, 2600, 3600, 4600SU, 2310, 2610, 2910, 3610, 3910, 4610SU, 231, 335, 531



D8NN3A302AA

Replaces D5NN3A302C, D5NN3A302D

Power Steering Cylinder End

Fits 5700, 6700, 7700, 6710, 7710, 8000, 9000, 8700, 9700, TW15, TW25, TW30



CAPN3300A

Power Steering Cylinder End

A - 1.875"
B - .500-20" NF Thread

Fits 3400, 335, 532 Industrial Models



D9NN3A302AB

Power Steering Cylinder End, R/H
Female Threads

A - 2.370"
B - 1.000"
C - .687" - 18 Thread

Fits 550, 555, 555A, 555B, 655, 655A



D9NN3A303AB

Power Steering Cylinder End, R/H
Male Threads

A - 2.000"
B - .687" - 18 Thread

Fits 550, 555, 555A, 555B, 655, 655A





Ford / New Holland

STEERING, SECTORS

E4NN3503CA

Steering Sector, Manual
2 Arm Style



Fits 2000, 3000, 2600, 3600, 4000SU, 4600SU, 2310,
2610, 2910, 3610, 3910, 4610, 231, 335, 531

E0NN3503CA

Steering Sector, Manual and Early Power
1 Arm Style

Fits 3500, 3550, 4000, 4100, 4600

D7NN3503E

Steering Sector, Power
1 Arm Style

Fits 4400-4500, 515



D7NN3503A

Steering Sector, Manual
1 Arm Style

Fits 5000, 5600, 6600

C5NN3503E

Steering Sector, Power

Fits 5000 1/1965-8/1970



STEERING, CONTROL VALVES

Ford / New Holland

F2NN3A244EA

Replaces E3NN3A244BA, D6NN3A244C, 81877995, 86585451

Steering Motor
Roll Pin Type Shaft

Fits 4000, 4200, 5000, 5100, 5200, 7000, 7100, 7200, 5700, 6700, 7700, 7710, 8000, 9000, 8600, 9600



E3NN3A244CB

Replaces 86585453

Steering Motor
Roll Pin Type Shaft

Fits 8700, 9700, TW10, TW20, TW30, TW5, TW15, TW25, TW35, 7810, 7910, 8210, 8530, 8630, 8730, 8830

F1NN3A244AA

Replaces 96604767

Steering Motor
Roll Pin Type Shaft

Fits 550, 555, 555A, 555B, 555C, 555D, 575D, 655, 655A, 655C, 655D, 675D, 6500, 7500, 750, 755, 755A, 755B

86585454

Replaces D8NN3A244AA

Steering Motor
Roll Pin Type Shaft

Fits 250C, 260C, 340, 340A, 340B, 345C, 345D, 445, 445A, 445C, 445D, 450, 540A, 540B, 545, 545C, 545D

FD11125B

Steering Motor
Roll Pin Type Shaft
This is an Economical Option to Replace Ross/Hydroglide Units in Most Applications (With Line Modification)



Fits 4000, 4200, 5000, 5100, 5200, 7000, 7100, 7200, 5700, 6700, 7700, 7710, 8000, 9000, 8600, 9600, 8700, 9700, TW10, TW20, TW30, TW5, TW15, TW25, TW35, 7810, 7910, 8210, 8530, 8630, 8730, 8830, 550, 555, 555A, 555B, 555C, 555D, 575D, 655, 655A, 655C, 655D, 675D, 6500, 7500, 750, 755, 755A, 755B, 250C, 260C, 340, 340A, 340B, 345C, 345D, 445, 445A, 445C, 445D, 450, 540A, 540B, 545, 545C, 545D

86602557

Replaces E4NN3A244AA

Orbital Hand Motor with Relief Valve
(Looks Different, But Works Well)



Fits 5610, 6610, 7610, 7710, 7810, 5900

83986295

Replaces E9NN3A244BA

Steering Motor

Fits 3230, 3430, 3930, 4130, 4630, 4830, 5030



F0NN3A244AA

Replaces 81863664

Steering Motor
For 4WD Tractors



Fits 5640, 6640, 7740, 7840, 8240, 8340, TS90, TS100, TS110, TS115

F0NN3A244BA

Replaces 81863600

Steering Motor
For 2WD Tractors



Fits 5640, 6640, 7740, 7840, 8240, 8340, TS90, TS100, TS110, TS115

82001904

Replaces 47137781, 47137782, 84266840

Steering Motor



Fits 2WD Tractors 4635, 4835, 5675, 6635, 7635, TL70, TL80, TL90, TL100, TL70A, TL80A, TL90A, TL100A, TS100A, TS110A, TS115A, T5040, T5050, T5060, T5070, T6010, T6020, T6030, T6040, T6050, T6070; 4WD Tractors 4635, 4835, 5635, TL70, TL70A

82001250

Replaces 47137771, 47137772, 84266839

Steering Motor



Fits 2WD Tractors 8160, 8260, 8360, 8560, TM115, TM120, TM125, TM130, TM135, TM140, TM150, TM155, TM165, TS125A, TS135A, (T6010, T6020, T6030, T6040, T6050, T6060, T6070 With heavy duty front end), (T7030, T7040, T7050, T7060 ALL -C5480); 4WD Tractors 5635, 6635, 7635, TL80, TL90, TL100, TL80A, TL90A, TL100A, TS125A, TS130A, TS135A, T5040, T5050, T5060, T5070



Ford / New Holland

STEERING, SECTOR PARTS

FOR TWO ARM POWER STEERING SECTOR

E1NN3N632AA

Upper Seal



C5NN3707A

Nut



310867

Spring Washer



LA33586A

Bearing and Races



87150S94

O-Ring (2 Required)



C5NN3A730B

Steering Valve Assembly
With Spool, Plungers, and Springs
(Must Use Check Valve and
Adapter Fitting From Old Valve)



C5NN3N739A

Lower Seal
(for Power Steering Adapter)



C5NN3N657A

Upper Bearing
(for Power Steering Adapter)



D9NN3N748AA

Power Steering Adapter



86512848

Replaces **C5NN3N655A**
Lower Bearing



D6NN3A710A

Worm Shaft, Power Steering



LA33579B

Plunger (For Power Steering Control Valve)



310960

Spring
(For Power Steering Control Valve)



C5NN3C615A

Side Sector Seal
.160" Thick, 1.445" O.D.



D6NN3C615A

Side Sector Seal
.245" Thick, 1.5" O.D.



87073S94

Replaces **9636445**
Steering Side Shaft Cover O-Ring



C5NN3586A

Steering Pitman Shaft Felt Washer



C7NN3N575A

Steering Sector Pitman
Shaft, R/H Single



C7NN3N576A

Steering Sector Pitman
Shaft, L/H Double



All Fit 2000, 3000, 4000SU, 2600, 3600, 4600SU, 2310, 2610, 2910, 3610, 3910, 4610SU 1/1981-9/1984, 3400, 231, 335, 531, 532 (Some Items Also Fit 600, 800, 601, 801, 2000-4000 4 Cylinder)



STEERING, SECTOR PARTS

Ford / New Holland

SBA334290220

Worm Shaft, Manual Steering (Approx 23 15/16" Long)
Fits 1000, 1600

SBA334291450

Worm Shaft, Manual Steering (Approx 21 11/16" Long)
Fits 1100, 1200, 1110, 1210

SBA334100050

Worm Shaft, Manual Steering (Approx 23 1/2" Long)
Fits 1500, 1700 1/1979 to 1/1982

SBA334290720

Worm Shaft, Manual Steering (Approx 25 11/16" Long)
Fits 1900

8N3575A

Worm Shaft, Manual Steering (Approx 20 1/8" Long)
Fits 8N Early 1/1948 to 12/1949

8N3575B

Worm Shaft, Manual Steering (Approx 21" Long)
Fits 8N Late 1/1950-12/1952

NAA3575C

Worm Shaft, Manual Steering (Approx 22 3/4" Long)
Fits NAA

NCA3575A

Worm Shaft, Manual Steering (Approx 23 3/8" Long)
Fits 600, 601, 800, 801, 2000, 4000, 55/64 4 Cylinder

D2NN3A710B

Worm Shaft, Manual Steering (Approx 26 1/8" Long)
Fits 2000, 3000, 4000SU, 2600, 3600, 4600SU,
231, 335, 531, 65/75

D2NN3A710D

Worm Shaft, Manual Steering (Approx 26 1/8" Long)
Fits 4000, 4600, 3500, 3550, 4100 3 Cylinder

310859

Worm Shaft, Power Steering (Approx 23 3/4" Long)
Fits 600, 800, 601, 801, 2000 and 4000 4 Cylinder

D6NN3A710A

Worm Shaft, Power Steering (Approx 26 9/16" Long)
Fits 2000, 3000, 2600, 3600, 4000SU, 4600SU,
231, 335, 531

D2NN3A710D

Worm Shaft, Power Steering (Approx 26 1/8" Long)
Fits 4000, 4600, 3500, 3550, 4100 3 Cylinder
With External P/S Cylinder

C5NN3A710A

Worm Shaft, Power Steering (Approx 28 13/16" Long)
Fits 5000, 7000 1/1965-8/1970
With P/S Cylinder in Front Support

D2NN3A710E

Worm Shaft, Power Steering (Approx 26 7/16" Long)
Fits 4400, 4500, 515



STEERING SECTOR SHAFTS

SBA334290230

Sector Shaft with Small Spline

A: Diameter 1.030"

B: Diameter 0.950"

Fits 1000, 1600 Early



SBA334290231

Sector Shaft with Large Spline

A: Diameter 1.100"

B: Diameter 1.030"

Fits 1000, 1600 Late

SBA334130041

Sector Shaft

Fits 1300, 1500, 1700 1/1979-1/1982



C7NN3N575A

Sector Shaft, R/H Single

C7NN3N576A

Sector Shaft, L/H Double

Fits 2000, 3000, 4000SU, 2600, 3600, 4600SU, 231, 335,
531, 3400 Manual and Power Steering





Ford / New Holland

STEERING, SECTOR PARTS

EDPN3500A

Steering Sector Repair Kit
For Steering Sectors Without Teflon Seals on Control Valve Spool (See Below Part Before Ordering)

Fits 4000, 5000, 7000

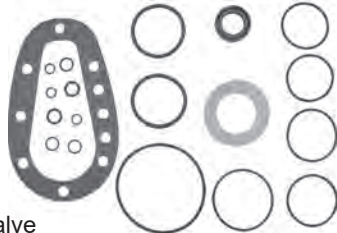

E0NN3A590AA

Teflon Seals for Steering Valve
Add 3 to EDPN3500A for 5600, 6600, 7600, 5610, 6610, 7610

HG500007

Replaces F1NN3N991A, 132554, 517416, 86585473

Steering Control Valve Upper Seal Kit
For Ross, TRW, and Hydraguide Units

Fits 5700, 6700, 7700, 5610, 5900, 6610, 7610, 7710, 7810, 8210, 8000, 9000, 8600, 9600, 8700, 9700, 8530, 8630, 8730, 8830, TW5, TW10, TW15, TW20, TW25, TW30, TW35, 250C, 260C, 340, 340A, 340B, 345C, 345D, 445, 445A, 445C, 450, 455, 455C, 455D, 545, 545A, 545B, 545C, 550, 555, 555A, 555B, 555C, 555D, 655A, 655B, 655C, 655D, 7500, 750, 755A, 755B, 755C

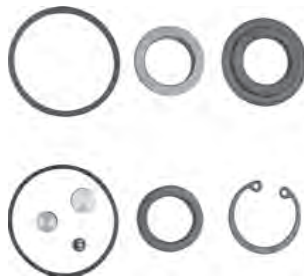

SRK632AA

Steering Shaft Repair Kit
For Tractors With Power Steering



Fits 600, 640, 611, 621, 631, 641, 651, 661, 671, 800, 840, 801, 811, 821, 831, 841, 851, 861, 871, 2000-4000 4 Cylinder, 2000, 3000, 4000SU, 2600, 3600, 4600, 4600SU, 2310, 2610, 2910, 3610, 3910, 4610, 5000, 7000, 5600, 6600, 7600, 5610, 6610, 7610, 231, 335, 531, 340, 540, 3400

E1NN3N632AA

Upper Seal

Fits 600, 800, 601, 801, 2000-4000 4 Cylinder, 2000, 3000, 4000SU, 5000, 2600, 3600, 4600SU, 5600, 6600, 7600, 2310, 2610, 2810, 2910, 3610, 3910, 4610, 5610, 6610, 7610



C9NN3C516B

Power Steering Control Valve Housing

Fits 5000, 7000, 5600, 6600, 7600



E0NN3C516BB

Power Steering Control Valve Housing

Fits 5610, 6610, 7610

E1ADKN3556

Steering Shaft Bearing and Race
For Manual Steering

Fits 4000, 5000, 4600, 5600, 6600, 3500, 4400, 4500



251296

Steering Shaft Shim

Fits 8N, 9N, 2N, NAA, 600, 700, 800, 900, 601, 701, 801, 901, 2000-4000 4 Cylinder



SBA334290161

Steering Shaft Shim

Fits 1500, 1700

D2NN3A566B

Dash Panel Grommet



C5NN3517A

Replaces D5NN3517A

Upper Steering Bushing

Fits Most Ford Tractors





STEERING, SECTOR PARTS & STEERING WHEELS Ford / New Holland

87073S94

Steering Side Shaft
Cover O-Ring



C5NN3C615A

Side Sector Seal
.160" Thick, 1.445" O.D.



D6NN3C615A

Side Sector Seal
.245" Thick, 1.5" O.D.



C5NN3N615A

Worm Shaft Bearing
for Manual Steering



C5NN3552A

Worm Shaft Race
for Manual Steering
1.75" O.D.



C7NN3552A

Worm Shaft Race
for Manual Steering
2.00" O.D.

Fits 8N, NAA, 600, 700, 800, 900, 601, 801, 2000-4000
4 Cylinder, 2000, 3000, 4000, 4000SU, 2600, 3600, 4600,
4600SU, 2310, 2610, 2810, 2910, 3610, 3910, 4610, 231,
335, 3400

E4NN3R803AA

Bearing Kit
For 10 Series Steering Sector and
Aftermarket Manual Steering Sectors



Fits 2310, 2610, 2910, 3610, 3910, 4610, 230A, 234, 530A

E0NN3600AA

Replaces 2N3600
Steering Wheel
Metal Spoke Type, Keyed Hub

Fits 9N, 2N



8N3600

Steering Wheel
Metal Spoke Type, Splined Hub

Fits 8N, NAA, 500, 600, 700, 800, 900, 501, 601, 701, 801,
901, 2000-4000 4 Cylinder

957E3600

Steering Wheel

Fits Dexta, Super Dexta



D6NN3600B

Replaces D2NN3600B,
83909785
Steering Wheel with Cap

Fits 2000, 3000, 4000, 4000SU, 2600, 3600, 4600,
4600SU, 5600, 6600, 7600, 2310, 2610, 2810, 2910, 3610,
3910, 4610, 5000, 5100, 5200, 7000, 7100, 7200, 5610,
6610, 7610, 231, 335, 531, 340, 540, 3400, 3500, 445,
4500

D7NN3600A

Replaces D2NN3600A
Steering Wheel, 15" Diameter

Fits 2000, 3000, 4000, 5000, 7000, 2600, 3600, 4600,
5600, 5700, 6600, 6700, 7600, 7700, 2610, 2910, 3610,
2910, 4610, 5610, 6610, 7610, 7710

D5NN3N602A

Steering Wheel Nut



Fits 9N, 2N, 8N, NAA, 500, 600, 700, 800, 900, 501, 601,
701, 801, 901, 2000-4000 4 Cylinder, 2000, 3000, 4000,
4000SU, 2600, 3600, 4600, 4600SU, 5600, 6600, 7600,
2310, 2610, 2810, 2910, 3610, 3910, 4610, 5000, 5100,
5200, 7000, 7100, 7200, 5610, 6610, 7610, 231, 335, 531,
340, 540, 3400, 3500, 445, 4500



Call Us: 1 (800) 462-7335

Ford / New Holland

STEERING, P/S PUMPS

C3NN3A674C

Replaces C0NN3A674F
Power Steering Pump
Without Reservoir and Pulley



Fits 500, 600, 700, 800, 900, 501,
601, 701, 801, 901, 2000-4000 4 Cylinder

E8NN3K514BA

Power Steering Pump
Round Style O-Ring Fitting



Fits 3230, 3430, 3930, 4130,
4630, 4830, 5030, 7/1990-5/1993

C7NN3A674F

Replaces 81816585
Power Steering Pump
Square Style 1250 PSI



Fits 2000, 3000, 4000, 5000, 7000, 3400, 3500, 4500

F1NN3K514BA

Replaces 82854836
Power Steering Pump Round Style



Fits 3230, 3430, 3930, 4130,
4630, 4830, 5030, 6/1993-Up

C7NN3A674B

Power Steering Pump
Square Style 1500 PSI



Fits 8000, 9000

E6NN3K514JA

Power Steering Pump
Round Style, 1600 PSI



Fits 5700, 6700, 7700, 6710, 7710

E6NN3K514EA

Power Steering Pump
Round Style 1100 PSI



Fits 2000, 3000, 4000, 5000, 7000,
2600, 3600, 4600, 5600, 6600, 6700,
7600, 7700

E6NN3K514TA

Power Steering Pump
Round Style, Long Canister



Fits 6710, 7710, 7810, 7910, 8210

E6NN3K514BA

Power Steering Pump
Round Style 850 PSI



Fits 2310, 2610, 2810, 2910,
3610, 3910, 4610SU, 230A,
335, 530A

D6NN3K514B

Power Steering Pump
Round Style



Fits 8000, 9000, 8600, 9600

E6NN3K514PA

Power Steering Pump
Round style (10 Series With
Relief Valve)



Fits 2610, 3610, 4610, 5610, 6610,
7610, 7710 (1981-5/1985)

D8NN3K514JD

Replaces E0NN3K514AB
Power Steering Pump
Round Style



Fits 8700, 9700, TW5,
TW10, TW15, TW20,
TW25, TW30, TW35

E6NN3K514AB

Power Steering Pump
Round Style (10 Series
Without Relief Valve)
Fits 5610, 6610, 7610 (5/1985-Up)
Series II Tractors





STEERING, P/S PUMPS & P/S TIE ROD ENDS

Ford / New Holland

E7NN3K514CA

Power Steering Pump
Round Style 1600 PSI

Fits 445, 445A, 545, 545A,
555, 555A, 555B



C5NN3A302B

Power Steering Cylinder End

Fits 2000, 2600, 3000, 3600, 4000SU,
2600, 3600, 4600SU, 2310, 2610, 2910,
3610, 3910, 4610SU, 231, 335, 531



E9NN3K514BA

Power Steering Pump
Round Style

Fits 455C, 555C,
575C, 655C



D8NN3A302AA

Replaces **D5NN3A302C,**
D5NN3A302D

Power Steering Cylinder End

Fits 5700, 6700, 7700, 6710, 7710, 8000,
9000, 8700, 9700, TW15, TW25, TW30



F2NN3K514AA

Power Steering Pump
Round Style

Fits 455D, 555D, 575D, 675D



CAPN3300A

Power Steering Cylinder End

A - 1.875"
B - .500-20" NF Thread

Fits 3400, 335, 532 Industrial Models



82991210

Replaces **5180267, A25XRP**
Power Steering Pump

Fits 4835, 5635, 7635, TL70, TL80, TL90, TL100



D9NN3A302AB

Power Steering Cylinder End, R/H
Female Threads

A - 2.370"
B - 1.000"
C - .687" - 18 Thread

Fits 550, 555, 555A, 555B, 655, 655A



EDPN3K758A

Power Steering Filter

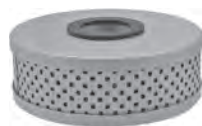

D2NN3A006B

P/S Reservoir Cap
for Round Style Pump

Fits All Ford with Round Style Pump



D9NN3A303AB

Power Steering Cylinder End, R/H
Male Threads

A - 2.000"
B - .687" - 18 Thread

Fits 550, 555, 555A, 555B, 655, 655A





Ford / New Holland

STEERING PARTS, POWER STEERING CYLINDERS



E2NN3A540BA

Replaces E4NN3A540AA

Power Steering Cylinder, 1/2" Rod

Fits 600, 700, 800, 601, 701, 801, 2000-4000
4 Cylinder, 2000, 3000, 4000SU, 2600, 3600, 4600SU,
2310, 2610, 2810, 2910, 3610, 3910, 4610, 231, 335, 531

D4NN3A540A

Replaces E9NN3A540AA

Power Steering Cylinder, 5/8" Rod (Also Replaces 1/2"
Cylinder Above)

Fits 600, 700, 800, 601, 701, 801, 2000-4000
4 Cylinder, 2000, 3000, 4000SU, 2600, 3600, 4600SU,
2310, 2610, 2810, 2910, 3610, 3910, 4610, 231, 335, 531

C5NN3A739G

Power Steering Cylinder, 5/8" Rod

Fits 340, 540, 3400 Industrial Tractors



85999337

**Replaces 85999104, D8NN3D547AB,
D8NN3D547AA**

Power Steering Cylinder, R/H

85999338

**Replaces 85999103, D8NN3A540AB,
D8NN3A540AA**

Power Steering Cylinder, L/H

Fits 250C, 340, 340A, 340B, 345C, 345D, 445, 445A,
445C, 445D, 540, 540A, 540B, 545, 545A, 545C, 545D,
550, 555, 555A, B, C, 655, 655A, B, C, D

E6NN3A540CA

Power Steering Cylinder



Fits 550, 555, 555A, 555B, 655, 655A

E6NN3A540BA

Replaces D5NN3A540A

Power Steering Cylinder



Fits 5700, 6700, 7700, 7710, 7810, 7910, 8210, 8700,
9700, TW5, TW15, TW25, TW35

E7NN3A540CB

Replaces 83981562

Power Steering Cylinder



Fits 3230, 3430, 3930, 4630, 4830, 5030 3/1/1990-
5/31/1994 Without Tie Rod Ends

E3NN3A540BA

Power Steering Cylinder



Fits 5110, 5610, 5610S, 6610, 6610S, 6810, 6810S, 7610,
7610S, 7810, 7810S

E9NN3A540BC

Replaces 81869701

Power Steering Cylinder



Fits 5640, 6640, 7740, 7840, 8240, 8340, TS90, TS100,
TS110

5189895

**Replaces 5142046,
5173144**

Power Steering Cylinder



Fits 3230, 3430, 3930, 4630, 4830, 5030 3/1/1990-
5/31/1994





STEERING PARTS, POWER STEERING CYLINDER PARTS Ford / New Holland

C5NN3A747A

Power Steering Cylinder Shaft



Fits 4500, 515, 535

CFPN3301C

Power Steering Cylinder Seal Kit



Fits 4400, 4500, 5000, 515, 535

E3NN3A747AA

Power Steering Cylinder Shaft



EFPN3301A

Power Steering Cylinder Repair Kit

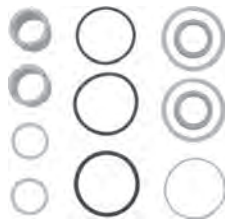

Fits 5610, 6610, 7610, 7810, 5900, 5640, 6640, 7740, 7840, 8240, TS90, TS100, TS110

D5NN3N797A

Replaces **D5NN3N699A**

Piston & Rod Assy
2.234" O.D.



Fits 5700, 6700, 7700, 7710, 7910, 8210, 8700, 9700, TW10, TW20, TW30

DGPN3301B

Seal Kit For Power Steering Cylinder

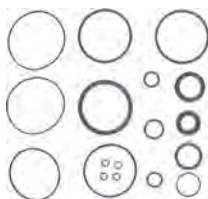

Fits 5700, 6700, 6710, 7700, 7710, 7910, 8210 8/1976-1/1987

E9NN3A747AA

Power Steering Cylinder Shaft



Fits 5640, 6640, 7740, 7840, 8240, 8340, TS90, TS100, TS110

EFPN3301A

Power Steering Cylinder Repair Kit

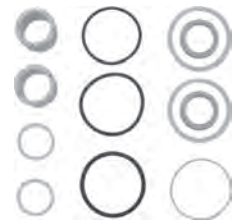

Fits 5610, 6610, 7610, 7810, 5900, 5640, 6640, 7740, 7840, 8240, TS90, TS100, TS110

E7NN3A747BA

Replaces **83983375**

Power Steering Cylinder Shaft
2WD Tractors



FP526

Power Steering Cylinder Seal Kit
2WD Tractors



Fits 3230, 3430, 3930, 4630, 4830, 5030

85999340

Power Steering Cylinder Seal Kit
For Ford 85999337 and 85999338
Power Steering Cylinders

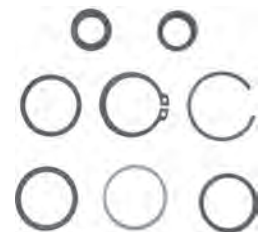

Fits 250, 260, 340A, 340B, 445, 445A, 450, 540A, 540B, 545A, 555C, 555D, 575D, 655C, 655D, 675D



Ford / New Holland

STEERING PARTS, ADD-ON KITS & PARTS

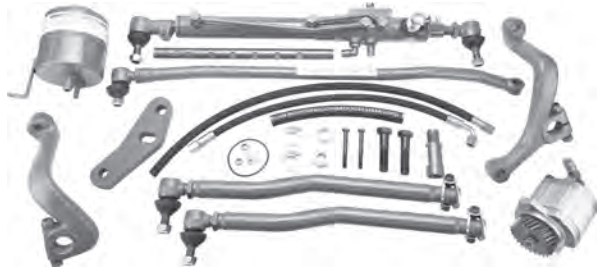

3000PSKIT

Power Steering Add-On Kit
For Diesel Tractors (Will Work on Gas Tractors
with Modifications)

Fits 2000, 3000, 2600, 3600, 4000SU, 4600SU

4000PSKIT

Power Steering Add-On Kit

Fits 4000, 4600

5000PSKIT

Power Steering Add-On Kit

Fits 5000, 7000, 5600, 6600, 7600

AH2015

Tie Rod End
For Aftermarket Power Steering



Fits 2000, 3000, 2600, 3600

ARM01

Spindle Arm, R/H
Add-On P/S



ARM02

Spindle Arm, L/H
Add-On P/S



Fits 2000, 3000, 4000, 4000SU, 2600, 3600, 4600SU,
2310, 2610, 2810, 2910, 3610, 3910, 4610



CLUTCH

Ford / New Holland

CKFD01

Clutch Kit

Contains Clutch, Pressure Plate, Release Bearing, Pilot Bearing, and Alignment Tool

9" Clutch Disc with 10 Splines



Fits 9N, 2N, 8N, NAA, 500, 600, 700, 800, 900

CKFD03

Clutch Kit

Contains Clutch, Pressure Plate, Release Bearing, Pilot Bearing, and Alignment Tool

10" Clutch Disc with 15 Splines



Fits 501, 601, 701, 801, 901, 2000 and 4000 4 Cylinder

CKFD02

Clutch Kit

Contains Clutch, Pressure Plate, Release Bearing, Pilot Bearing, and Alignment Tool

10" Clutch Disc with 10 Splines



Fits 500, 600, 700, 800, 900

CKFD04

Clutch Kit

Contains Clutch, Pressure Plate, Release Bearing, Pilot Bearing, No Alignment Tool Needed

Double Clutch For Tractors With Live PTO

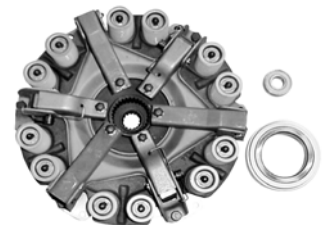

Fits 500, 600, 700, 800, 900, 501, 601, 701, 801, 901, 2000 and 4000 4 Cylinder, Dexta, Super Dexta

Ford / New Holland

CLUTCH

3000 Series Tractors

CKFD05

Clutch Kit
Contains Clutch, Pressure Plate, Release Bearing, Pilot Bearing, and Alignment Tool



For Tractors With Live PTO
11", 15 Spline Spring Center Main Disc and Dual Style Two Stage Pressure Plate

Individual Parts Sold Below

E8NN7550AA

Clutch Disc
11", 15 spline



D8NN7502AA

Dual Pressure Plate



E4NN7580AA

Throw Out Bearing



C5NN7600A

Pilot Bearing

Fits 2000, 3000, 2600, 3600, 2310, 2610, 2810, 2910, 3610, 231, 335, 531, 3400, 3500

CKFD06

Clutch Kit
Contains Clutch, Pressure Plate, Release Bearing, Pilot Bearing, and Alignment Tool



For Tractors With Live PTO
11", 10 Spline Spring Center Main Disc and Dual Style Two Stage Pressure Plate

Individual Parts Sold Below

E5NN7550BB

Clutch Disc
11", 10 spline



D8NN7502AA

Dual Pressure Plate



E4NN7580AA

Throw Out Bearing



C5NN7600A

Pilot Bearing

Fits 2000, 3000, 2600, 3600, 2310, 2610, 2810, 2910, 3610, 231, 335, 531, 3400, 3500

CKFD16

Clutch Kit
Contains Clutch, Pressure Plate, Release Bearing, Pilot Bearing, and Alignment Tool



For Tractors With Single Clutch
11", 10 Spline Spring Center Disc and Single Style Three Lever Pressure Plate

Individual Parts Sold Below

E5NN7550BB

Clutch Disc
11", 10 spline



C9NN7563E

Single Pressure Plate



787580

Throw Out Bearing



C5NN7600A

Pilot Bearing

Fits 2000, 2100, 2110, 2150, 2300, 2310, 2600, 2610, 2810, 2910, 3000, 3055, 3100, 3120, 3190, 3300, 3310, 3330, 3400, 3500, 3600, 3610, 3900, 3910, 4000, 4100, 4110, 4140, 4200, 4330, 4340, 4410, 5000, 5100, 5110, 5190, 5200, 5340, 230A, 231, 233, 234, 333, 334, 335, 530A, 531

CKFD17

Clutch Kit
Contains Clutch, Pressure Plate, Release Bearing, Pilot Bearing, and Alignment Tool



For Tractors With Single Clutch
11", 15 Spline Spring Center Disc and Single Style Three Lever Pressure Plate

Individual Parts Sold Below

E8NN7550AA

Clutch Disc
11", 15 spline



C9NN7563E

Single Pressure Plate



787580

Throw Out Bearing



C5NN7600A

Pilot Bearing

Fits 2000, 2100, 2110, 2150, 2300, 2310, 2600, 2610, 2810, 2910, 3000, 3055, 3100, 3120, 3190, 3300, 3310, 3330, 3400, 3500, 3600, 3610, 3900, 3910, 4000, 4100, 4110, 4140, 4200, 4330, 4340, 4410, 5000, 5100, 5110, 5190, 5200, 5340, 230A, 231, 233, 234, 333, 334, 335, 530A, 531

CLUTCH

Ford / New Holland

4000 Series Tractors

CKFD07

Clutch Kit
Contains Clutch, Pressure Plate,
Release Bearing, Pilot Bearing,
and Alignment Tool



**For Tractors With Independent PTO
11", 15 Spline Spring Center Main Disc and 11"
Single Pressure Plate With 29 Spline PTO Hub**

Individual Parts Sold Below

E8NN7550AA

Clutch Disc
11", 15 Spline



C5NN7563U

Pressure Plate
Uses 8 Mounting Bolts

E4NN7580AA

Throw Out Bearing



C5NN7600A

Pilot Bearing
Fits 4000, 4600, 4610

CKFD08

Clutch Kit
Contains Clutch, Pressure Plate,
Release Bearing, Pilot Bearing,
and Alignment Tool



**For Tractors With Independent PTO
13", 10 Spline Spring Center Main Disc and 13"
Single Pressure Plate With 29 Spline PTO Hub**

Individual Parts Sold Below

E7NN7550BB

Replaces E5NN7550AA,
E7NN7550BA, 82004604

Clutch Disc
13", 10 Spline



C5NN7563AC

Single Pressure Plate

E4NN7580AA

Throw Out Bearing



C5NN7600A

Pilot Bearing

Fits 4000, 4600, 2810, 3610, 3910, 4110, 4610, 3230,
3430, 3930, 4830, 5030, 3500, 3550, 4400, 250C, 260C,
335, 340, 340A, 340B, 420, 445, 445A, 455, 515, 535, 540,
540A, 540B, 545, 545A, 550, 555, 555A, 555B, 655, 655A

CKFD09

Clutch Kit
Contains Clutch, Pressure Plate,
Release Bearing, Pilot Bearing,
and Alignment Tool



**For Tractors With Independent PTO
11", 10 Spline Spring Center Main Disc and 11"
Single Pressure Plate With 29 Spline PTO Hub**

Individual Parts Sold Below

E5NN7550BB

Clutch Disc
11", 10 Spline



C5NN7563U

Pressure Plate
Uses 8 Mounting Bolts

E4NN7580AA

Throw Out Bearing

C5NN7600A

Pilot Bearing
Fits 4000, 4600, 4610

Ford / New Holland

CLUTCH

5000 Series Tractors

CKFD10

Clutch Kit
Contains Clutch, Pressure Plate, Release Bearing, Pilot Bearing, and Alignment Tool



For Tractors With Independent PTO
12", 25 Spline Spring Center Main Disc and 12" Single Pressure Plate

Individual Parts Sold Below

E3NN7550EA

Replaces F0NN7550HA

Clutch Disc
12", 25 Splines



E0NN7563CA

Replaces 83925716

Pressure Plate

E4NN7580AA

Throw Out Bearing

C5NNN779B

Replaces F0NNN779AA

Pilot Bearing

Fits 5000, 5100, 5200, 7000, 7100, 7200, 5600, 6600, 7600, 6700, 7600, 7700, 5610, 6610, 7610, 6710, 7710

CKFD11

Clutch Kit
Contains Clutch, Pressure Plate, Release Bearing, Pilot Bearing, and Alignment Tool



For Tractors With Independent PTO
13", 25 Spline Spring Center Main Disc and 13" Single Pressure Plate

Individual Parts Sold Below

D9NN7550CA

Replaces D2NN7550A, E8NN7550KA, F0NN7550AA

Clutch Disc
13", 25 Splines



D8NN7563AB

Pressure Plate

E4NN7580AA

Throw Out Bearing

C5NNN779B

Replaces F0NNN779AA

Pilot Bearing

Fits 5000, 5100, 5200, 7000, 7100, 7200, 5600, 6600, 7600, 6700, 7700

CKFD12

Clutch Kit
Contains Clutch, Pressure Plate, Release Bearing, Pilot Bearing, and Alignment Tool



For Tractors With Independent PTO
12", 10 Spline Spring Center Main Disc and 12" Single Pressure Plate

Individual Parts Sold Below

E3NN7550CA

Clutch Disc
12", 10 Spline

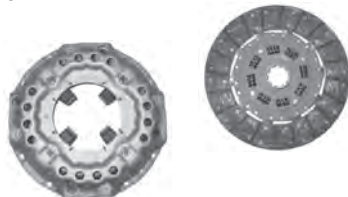

E0NN7563CA

Replaces 83925716

Pressure Plate

E4NN7580AA

Throw Out Bearing

C5NNN779B

Replaces F0NNN779AA

Pilot Bearing

Fits 5000, 5100, 5200, 7000, 7100, 7200, 5600, 6600, 7600, 6700, 7600, 7700, 5610, 6610, 7610, 6710, 7710

CKFD13

Clutch Kit
Contains Clutch, Pressure Plate, Release Bearing, Pilot Bearing, and Alignment Tool



For Tractors With Independent PTO
13", 10 Spline Spring Center Main Disc and 13" Single Pressure Plate

Individual Parts Sold Below

E3NN7550DA

Replaces D9NN7550AA

Clutch Disc
13", 10 Spline



D8NN7563AB

Pressure Plate

E4NN7580AA

Throw Out Bearing

C5NNN779B

Replaces F0NNN779AA

Pilot Bearing

Fits 5000, 5100, 5200, 7000, 7100, 7200, 5600, 6600, 7600, 6700, 7600, 7700, 5610, 6610, 7610, 6710, 7710

CLUTCH

Ford / New Holland

40 & TS Series Tractors

CKFD14

Clutch Kit

Contains Clutch, Pressure Plate, Release Bearing, Pilot Bearing, and Alignment Tool

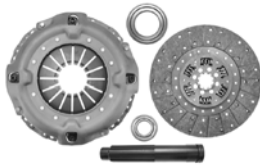

For Tractors With Independent PTO
13", 10 Spline Spring Center Main Disc and
13" Diaphragm Style Single Pressure Plate

Individual Parts Sold Below

82011593

Replaces E7NN7550EA,
E9NN7550BA, F1NN7550AA

Clutch Disc
13", 10 Spline

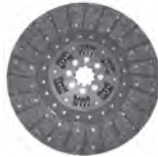

82011590

Replaces 81871403,
82001664, 82006025,
E9NN7563AA, F1NN7563AA

Pressure Plate



E4NN7580AA

Throw Out Bearing



C5NNN779B

Replaces F0NNN779AA

Pilot Bearing

Fits 5640, 6640, 7740, 8240, 8340, TS90, TS100, TS110



F0NN7A543AB

Replaces 81864590,
81867084,

F0NN7A543AA

Clutch Master Cylinder



Fits 5640, 6640, 7740, 7840, 8240, 8340, TS100, TS100A,
TS110, TS110A, TS115, TS120A



40 & TS Series Tractors

CKFD15

Clutch Kit

Contains Clutch, Pressure Plate, Release Bearing, Pilot Bearing, and Alignment Tool



For 12 x 12 Transmissions
For Tractors With Independent PTO
13", 10 Spline Spring Center Main Disc and
13" Diaphragm Style Single Pressure Plate

Individual Parts Sold Below

82011593

Replaces E7NN7550EA,
E9NN7550BA, F1NN7550AA

Clutch Disc
13", 10 Spline

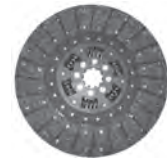

82011590

Replaces 81871403,
82001664, 82006025,
E9NN7563AA, F1NN7563AA

Pressure Plate



82005471

Replaces 81864436,
F0NN8200AA

Clutch Release Bearing
For 12 x 12 Transmissions



C5NNN779B

Replaces F0NNN779AA

Pilot Bearing

Fits 5640, 6640, 7740, 7840, 7840O, 8240, 8340, T6010,
T6020, T6030, T6050, TS100, TS100A, TS110, TS110A,
TS115, TS115A, TS90



Ford / New Holland

TRANSMISSION, 4 SPEED

311202

Replaces 311212
Input Shaft Tube
4 Speed



Fits 601, 701, 801, 901, 2000-4000 4 Cylinder

C3NN7015D

Input Shaft
Length 8"
For Step Up Step Down
Transmission



Fits 600, 700, 800, 900, 601, 701, 801, 901, 2000-4000
4 Cylinder

C5NN7A284B

Input Shaft Tube
4 Speed



Fits 2000, 3000, 3400, 3500

C5NN7015T

Input Shaft
Length 9"
For Step Up Step Down
Transmission



Fits 2000, 3000, 2600, 3600, 4600, 4600SU, 5600, 6600,
7600, 3400, 3500

2N7017A

Input Drive Shaft
10 Splines, 20 Helical Teeth



Fits 9N, 2N, 8N, NAA, 500, 600, 700, 800, 900

8N7111

Counter Shaft
For 4 Speed Transmission



Fits 8N

311203

Input Drive Shaft
4 Speed, 15 Splines,
20 Teeth, 17.00" Long



Fits 601, 701, 801, 901, 2000-4000 4 Cylinder

NAA7111C

Counter Shaft
For 4 Speed Transmission



Fits NAA

C5NN7017B

Input Drive Shaft
4 Speed, 15 Splines,
20 Teeth, 22.62" Long



Fits 2000, 3000, 3400, 3500

C5NN7N109A

Replaces NDA7111C
Counter Shaft
For 4 Speed Transmission



Fits 500, 600, 700, 800, 900, 501, 601, 701, 801, 901,
2000-4000 4 Cylinder, 2000, 3000, 3400, 3500



TRANSMISSION, 4 SPEED

Ford / New Holland

B9NN7114A

Countershaft 2nd Gear
17 Teeth
4 Speed



B9NN7A381B

Replaces 8N7101B
Main Shaft 2nd Gear
56 Teeth
4 Speed



Fits 8N, 9N, 2N, NAA, 600, 700, 800, 900, 601, 701, 801, 901, 2000-4000 4 Cylinder, 2000, 3000, 3400

NCA717A

PTO Coupler



Fits 600, 700, 800, 900, 601, 701, 801, 901, 2000-4000 4 Cylinder

NAA722A

PTO Stop



Fits 8N, 9N, 2N, NAA, 500, 600, 700, 800, 900, 501, 601, 701, 801, 901, 2000-4000 4 Cylinder, 2000, 3000, 3400

Ford / New Holland

TRANSMISSION, 5 SPEED

311260

Clutch Release Bearing Carrier
5 Speed Transmission
With Live PTO 1/1958 Up



Fits 501, 601, 701, 801, 901, 2000-4000 4 Cylinder

NDA701B

Replaces NDA702B
PTO Countershaft
For 5 Speed Transmission



Fits 600, 700, 800, 900, 601, 701, 801, 901, 2000-4000 4 Cylinder

311261

Input Shaft Tube
5 Speed Transmission
With Live PTO 1/1958 Up



Fits 501, 601, 701, 801, 901, 2000-4000 4 Cylinder

NCA717A

PTO Coupler



Fits 600, 700, 800, 900, 601, 701, 801, 901, 2000-4000 4 Cylinder

311649

Clutch Release Fork
5 Speed Transmission
With Live PTO 1/1958 Up



Fits 501, 601, 701, 801, 901, 2000-4000 4 Cylinder

NAA722A

PTO Stop



Fits 8N, 9N, 2N, NAA, 500, 600, 700, 800, 900, 501, 601, 701, 801, 901, 2000-4000 4 Cylinder, 2000, 3000, 3400

311249

PTO Input Shaft
5 Speed Transmission
With Live PTO 1/1958 Up
7 13/16" Long



Fits 501, 601, 701, 801, 901, 2000-4000 4 Cylinder

NDA7137A

3rd Gear
For 5 Speed Transmission



Fits 501, 601, 701, 801, 901, 2000-4000 4 Cylinder



TRANSMISSION, 6 & 8 SPEED

Ford / New Holland

E1NN7571CA

Throw Out Bearing Hub
2.055" I.D.

Fits 5610, 6610, 7610, 6710, 7710



C5NN7571H

Throw Out Bearing Hub
1.94" I.D.

Fits 5000, 5100, 5200, 7000, 7100, 7200, 5600, 6600, 7600, 6700, 7700

C5NN7503H

Release Fork Shaft
For Double Clutch
Adjusting Bolt Type
Bolt Not Included

Fits 2000, 3000, 3400 1/1965-3/1968



C7NN7N515C

Replaces C5NN7N515A
Release Bearing Fork
With Spring Tab For Single
and Double Clutch
4.5" Fork Spread, 2" Wide Base

Fits 2000, 3000, 4000, 3400, 4400 1/1965-9/1969



C5NN7A615A

Clutch Shaft Bushing

Fits 2000, 3000, 4000, 4000SU, 2600, 3600, 4600, 4600SU, 5000, 5100, 5200, 7000, 7100, 7200, 5600, 6600, 7600, 6700, 7700, 5610, 6610, 7610, 6710, 7710, 8000, 9000, 8600, 9600, 8700, 9700, TW5, TW10, TW15, TW20, TW25, TW30, TW35, 2310, 2610, 2810, 2910, 3610, 3910, 4610, 231, 335, 531, 340, 540, 3400, 3500, 445, 4500



C5NN7N541B

Input Shaft Tube
1.920" O.D.

Fits 5000, 5100, 5200, 7000, 7100, 7200, 5600, 6600, 7600



E0NN7N541BB

Replaces E0NN7N541BC

Input Shaft Tube
2.045" O.D.

Fits 5610, 6610, 7610, 5640, 6640, 7740

C5NN7017H

Input Drive Shaft
17.66" Long
15 Spline, 17 Teeth

Fits 2000



C7NN7017AB

Input Drive Shaft
17.66" Long
10 Spline, 19 Teeth

Fits 2000, 3000, 2600, 3600



C5NN772A

PTO Input Shaft
For Live PTO

Fits 2000, 3000, 2600, 3600, 2310, 2610, 2810, 2910, 3610, 231, 335, 3400, 3500





Ford / New Holland

TRANSMISSION, 6 & 8 SPEED

C5NN772C

PTO Input Shaft
17 Helical Teeth, 11 3/4" Long



Fits 4000 with Industrial PTO

D1NN772B

PTO Input Shaft
15 Straight Teeth, 11 3/4" Long



Fits 4000-4610 with Industrial PTO, 4000, 4600, 3910, 4610

C5NN7017A

Input Drive Shaft, Hollow
19.29" Long
25 Spline, 20 Teeth



Fits 5000, 5100, 7000, 7100, 5600, 6600, 6700, 7600, 7700

E0NN7017HA

Input Drive Shaft, Hollow
19.22" Long, 10 Spline, 20 Teeth
Spline Flange is 1.72" from End



Fits 5610, 6610, 7610

E2NN7017EA

Input Drive Shaft, Hollow
19.22" Long, 10 Spline, 20 Teeth
Spline Flange is 1.46" from End



Fits 5610, 6610, 7610, 7710, TS Series

D1NN791A

PTO Drive Gear
50 Straight Teeth



Fits 4000, 4600, 3910, 4610

C5NN7113D

Countershaft Gear
30 & 56 Teeth



Fits 2000, 3000, 2600, 3600, 2310, 2610, 2810, 2910, 3610, 3910, 4610

C5NN7B340A

3rd Gear
28 & 35 Teeth
1.80" I.D.



Fits 2000, 3000, 2600, 3600, 2310, 2910, 3610

C9NN7N315B

Replaces E6NN7N315AA
3rd Gear
28 & 35 Teeth
1.555" I.D.



Fits 2310, 2610, 2810, 2910, 3610, 3910, 4610, 4000, 4600, 3910, 4610, 5000, 5100, 5200, 7000, 7100, 7200, 5600, 6600, 7600, 6700, 7700, 5610, 6610, 7610, 6710, 7710

C5NN7C094A

Main Shaft
30 & 16 Teeth
8 Speed



Fits 5000, 5100, 5300, 7000, 7100, 7200

TRANSMISSION, 6 & 8 SPEED

Ford / New Holland

C9NN7C094B

Replaces **C5NN7C094C**

Main Shaft
With PTO & Without Dual
Power
30 & 18 Teeth, 9.937" Long



Fits 5000, 5100, 5200, 7000, 7100, 7200, 5600, 6600,
7600, 6700, 7700, 5610, 6610, 7610, 6710, 7710

E2NN7C094DA

Replaces **E7NN7C094AA**

Main Shaft
With PTO & With Dual Power
30 & 18 Teeth



Fits 5000, 5100, 5200, 7000, 7100, 7200, 5600, 6600,
7600, 6700, 7700

C5NN7C095D

Main Shaft



Fits 2000, 3000, 2600, 3600, 3400, 3500

C9NN7111B

Replaces **C5NN7111G**

Countershaft
2.065" I.D.



Fits 5000, 5100, 5200, 7000, 7100, 7200, 5600, 6600,
7600, 6700, 7700, 5610, 6610, 7610

E6NN7111AA

Replaces **D2NN7111A**

Countershaft
2.125" I.D.



Fits 5000, 5100, 5200, 7000, 7100, 7200, 5600, 6600,
7600, 6700, 7700, 5610, 6610, 7610, 5640, 6640, 7740,
7840, 8240, 8340

C5NN7211F

Pressed Steel Shift Top with Levers
For 8 Speed Transmission
With Internal Neutral Safety Switch



D3NN7A020B

Dipstick for Shift Top



D8NN7223AA

Replaces **82004680**,
C5NN7N225A, **C5NN7N225B**,
C5NN7N225C, **D5NN7223B**,
E6NN7223AA

Shift Top Gasket

Fits 2000, 3000, 4000, 4000SU, 2600, 3600, 4600SU,
2310, 2610, 2810, 2910, 3610, 3910, 4610, 231, 335,
531, 340, 540, 3400, 3500, 445, 4500



C5NN7211E

Cast Iron Shift Top with Levers
For 6 & 8 Speed Transmission
With Internal Neutral Safety Switch



D3NN7A020B

Dipstick for Shift Top



D8NN7223AA

Replaces **82004680**,
C5NN7N225A, **C5NN7N225B**,
C5NN7N225C, **D5NN7223B**,
E6NN7223AA

Shift Top Gasket

Fits 2000, 3000, 4000, 4000SU, 2600, 3600, 4600SU,
2310, 2610, 2810, 2910, 3610, 3910, 4610, 231, 335,
531, 340, 540, 3400, 3500, 445, 4500



C5NN7222R

Shift Top with Levers



Fits 5000, 7000, 5600, 6600, 7600



Call Us: 1 (800) 462-7335

Ford / New Holland

TRANSMISSION, 6 & 8 SPEED

C5NN7213A

Replaces 957E7231A
Shift Knob Main Lever



E440GB9

Shift Knob
Hi-Lo

Fits 2000, 3000, 4000, 4000SU, 2600, 3600, 4600SU, 2310, 2610, 2810, 2910, 3610, 3910, 4610, 231, 335, 531, 340, 540, 3400, 3500, 445, 4500



E62GE9

Transmission Countershaft Seal

Fits Dexta, Super Dexta, 2600, 3600, 4600, 4600SU, 5600, 6600, 7600, 2310, 2610, 2810, 2910, 3610, 3910, 4610, 2000, 3000, 4000, 5000

E8NN7231AA

Replaces C5NN7231B
Shift Fork 2nd & 6th



Fits 5000, 5100, 5200, 7000, 7100, 7200, 5600, 6600, 7600, 6700, 7700, 5610, 6610, 7610, 6710, 7710

E42GA9

Transmission Secondary Output Shaft Seal

Fits Dexta, Super Dexta, 2000, 3000, 4000, 4000SU, 2600, 3600, 4600, 4600SU, 5600, 6600, 7600

C5NN7N054B

Transmission Front Plate



Fits 5000, 7000

D9NN7R510BA

Input Shaft Seal with Transmission PTO

Fits Dexta, Super Dexta, 2000, 3000, 4000, 4000SU, 2600, 3600, 4600SU, 2310, 2610, 2810, 2910, 3610, 3910, 4610

D8NN7N054BA

Replaces D2NN7N054A,
D2NN7N054B

Transmission Front Plate



Fits 5000, 7000, 5600, 6600, 7600, 5610, 6610, 7610, 8210

D9NN7048BA

Replaces D9NN7048AA, D2NN7048A
Input Shaft Seal with Live or Independent PTO

Fits 5000, 5100, 5200, 7000, 7100, 7200, 5600, 6600, 7600, 6700, 7700, 5610, 6610, 7610, 6710, 7710

E6NN7N057AA

Replaces C5NN7N057A
Transmission Front Plate
Gasket



Fits 2000, 3000, 4000, 5000, 7000, 2600, 3600, 4600, 5600, 5700, 6600, 6700, 7600, 7700, 2610, 2910, 3610, 2910, 4610, 5610, 6610, 7610, 7710

C5NN77086A

Transmission Output Shaft Seal

Fits 2000, 3000, 4000, 4000SU, 2600, 3600, 4600, 4600SU, 5600, 6600, 7600, 2310, 2610, 2810, 2910, 3610, 3910, 4610, 4000, 4600, 3910, 4610, 5000, 5100, 5200, 7000, 7100, 7200, 6700, 7700, 5610, 6610, 7610, 6710, 7710



TRANSMISSION, 6 & 8 SPEED

Ford / New Holland

TG3000

Transmission Gasket Set

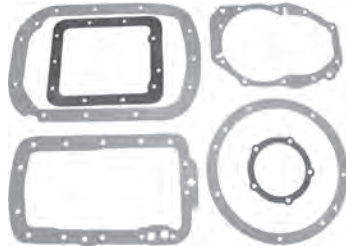

Fits 2000, 3000, 4000, 4000SU, 2600, 3600, 4600, 4600SU, 2310, 2610, 2810, 2910, 3610, 3910, 4610SU, 231, 335, 531, 340, 540, 3400, 3500, 445, 4500, 340, 340A, 340B, 445, 445A, 531, 542, 540, 540A

TG5000

Transmission Gasket Set

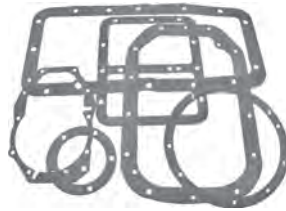

Fits 5000, 7000, 5600, 6600, 7600, 5610, 6610, 7610



Call Us: 1 (800) 462-7335

Ford / New Holland

TRANSMISSION, 6 CYLINDER, Dexta, Super Dexta

C7NN7017A

Input Shaft
15.89" Long



Fits 8000, 9000 1/1968-8/1969

D8NN7017AA

Input Shaft
15.28" Long



Fits 8000, 9000, 8600, 9600, 8700, 9700, TW10, TW20, TW30, TW5, TW15, TW25, TW35 9/1969-1990

C7NN7N329A

Hi-Lo Shift Arm



Fits 8000, 9000, 1/1968-9/1972

D3NN7N329A

Hi-Lo Shift Arm



Fits 8000, 9000, 8600, 9600, 10/1972-7/1976

C7NN7A247A

Neutral Safety Switch



Fits Most Fords 10/1966 Up

957E7061E

Main Shaft



Fits Dexta

960E7061A

Main Shaft



Fits Super Dexta

957E7017C

Input Drive Shaft
17 Teeth



Fits Dexta and Super Dexta

C5NN7213A

Replaces 957E7231A
Shift Knob Main Lever



E440GB9

Shift Knob
Hi-Lo



957E7220ASM

Shift Top
Without Knobs



957E7210C

Main Gear Shift Lever



957E7222

Gear Shift Plate



Fits Dexta, Super Dexta



TRANSMISSION, Dual Power

Ford / New Holland

D2NN7017A

Replaces 81826577

Input Drive Shaft

8.8125" Long

20 Spline



Fits 5000, 7000, 5600, 6600, 7600, 7700, 5610, 6610, 6710, 7610, 7710, 7810, 8010, 5640, 6640, 7740, 7840, 8240
With Dual Power Less Synchronized Transmission

E0NN7R036AB-B

Replaces 83931457, D0NN7R036A,
D0NN7R036B, D2NN7R036A, D2NN7R036B,
D3NN7R036A, D5NN7R036A, D5NN7R036B,
D6NN7R036A, D8NN7R036AA, E0NN7R036AA,
E0NN7R036AB

Clutch Pack Housing without Clutches



Fits 5000, 5100, 5200, 7000, 7100, 7200, 5600, 6600,
7600, 6700, 7700, 5610, 6610, 7610, 6710, 7710, 8000,
9000, 8600, 9600 8700, 9700, TW5, TW10, TW15, TW20,
TW25, TW30, TW35



Ford / New Holland

TRANSMISSION, SHUTTLE

86516596

Replaces **E4NN7A103AA**,
C5NN7A103F, **D2NN7A103A**

Transmission Pump
For Torque Converter
Transmission



Fits 3500, 3550, 4400, 4500, 340, 340A, 340B, 420, 445, 445A, 455, 535, 540, 540A, 540B, 545, 545A, 555, 555A, 555B, 655, 655A

C5NN7N168A

Bearing, Input Reverse Gear



Fits 3500, 3550, 4400, 4500, 340, 340A, 340B, 420, 445, 445A, 455, 535, 540, 540A, 540B, 545, 545A, 555, 555A, 555B, 655, 655A

C7NN6N638A

Replaces **C5NN6406B**

Torque Converter
Drive Plate



Fits 3500, 3550, 4400, 4500, 340, 340A, 340B, 420, 445, 445A, 455, 535, 540, 540A, 540B, 545, 545A, 555, 555A, 555B, 655, 655A

87061S95

O-Ring for Forward
and Reverse Piston



Fits 3500, 3550, 4400, 4500, 340, 340A, 340B, 420, 445, 445A, 455, 535, 540, 540A, 540B, 545, 545A, 555, 555A, 555B, 655, 655A

C0NN7C000A

O-Ring for Forward
and Reverse Piston



Fits 3500, 3550, 4400, 4500, 340, 340A, 340B, 420, 445, 445A, 455, 535, 540, 540A, 540B, 545, 545A, 555, 555A, 555B, 655, 655A

1P77518A

Clutch Plate
External Spline



85999292

Replaces **1P77519A1**

Clutch Plate
Internal Spline



Fits 3500, 3550, 4400, 4500, 340, 340A, 340B, 420, 445, 445A, 455, 535, 540, 540A, 540B, 545, 545A, 555, 555A, 555B, 655, 655A

D8NN7N089AA

Transmission Pump Seal



Fits 3500, 3550, 4400, 4500, 340, 340A, 340B, 420, 445, 445A, 455, 535, 540, 540A, 540B, 545, 545A, 555, 555A, 555B, 655, 655A



TRANSMISSION, SHUTTLE

Ford / New Holland

C5NN7N026A

Ring, Input Shaft Oil Tube Seal
5/8" O.D. (2 Required)



Fits 3500, 3550, 4400, 4500, 340, 340A, 340B, 420, 445, 445A, 455, 535, 540, 540A, 540B, 545, 545A, 555, 555A, 555B, 655, 655A

C5NN7A448B

Metal Seal Ring, Medium
Fits on C5NN7015V and D9NN7015BA
Input Shafts (3 Required)



Fits 3500, 3550, 4400, 4500, 340, 340A, 340B, 420, 445, 445A, 455, 535, 540, 540A, 540B, 545, 545A, 555, 555A, 555B, 655, 655A

C5NN7A448A

Metal Seal Ring, Large
Fits on C5NN7017AC Input Shaft
(3 Required)



Fits 3500, 3550, 4400, 4500, 340, 340A, 340B, 420, 445, 445A, 455, 535, 540, 540A, 540B, 545, 545A, 555, 555A, 555B, 655, 655A

C5NN7N142A

Seal, Shift Valve to Housing



Fits 3500, 3550, 4400, 4500, 340, 340A, 340B, 420, 445, 445A, 455, 535, 540, 540A, 540B, 545, 545A, 555, 555A, 555B, 655, 655A

1P77836A

Trans Pump Gasket



Fits 3500, 3550, 4400, 4500, 340, 340A, 340B, 420, 445, 445A, 455, 535, 540, 540A, 540B, 545, 545A, 555, 555A, 555B, 655, 655A

KPN502250A

Transmission Gasket And Seal Kit
For Torque Converter Transmissions

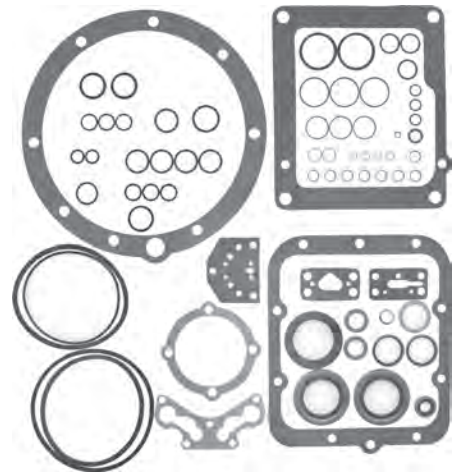

Fits 3500, 3550, 4400, 4500, 340, 340A, 340B, 420, 445, 445A, 455, 535, 540, 540A, 540B, 545, 545A, 555, 555A, 555B, 655, 655A

Ford / New Holland

TRANSMISSION, NEW HOLLAND

5186629

Replaces 5161828

Synchronizer, Forward and Reverse



Fits 4030, 4230, 4430, 4835, 5530, 5635, 6530, 6635, 7635, T5040, T5050, T5060, TD70D, TD80D, TD90D, TD95D, TL70, TL80, TL80A, TL90, TL90A

47131588

Replaces 5196242, 82016904

Synchronizer, 1st and 2nd Gear



Fits 5640, 6640, 7740, 7840, 8240, 8340, TS90, TS100, TS115, TS100A, TA115A, TS125A, TS135A, T6010, T6020, T6030, T6050, T6070

82855604

Replaces 81866839, F1NN7124CA

Synchronizer, High and Medium



Fits 5640, 6640, 7740, 8240, 8340, TS90, TS100, TS110, TS115, TS6020, TS6040

82016905

Replaces 82855607, 87759637

Synchronizer, 3rd and 4th Gear



Fits 5640, 6640, 7740, 8240, 8340, TS90, TS100, TS110, TS115, TS6020, TS6040

82001900

Replaces 81866841, F0NN7124GB

Synchronizer, Forward and Reverse



Fits 5640, 6640, 7740, 7840, 8240, 8340, TS90, TS100, TS115



PTO

Ford / New Holland



9N700-38
1 3/8" PTO Conversion
Fits 8N, 9N, 2N

NAA700-38
1 3/8" PTO Conversion
Fits NAA

NCA700-38
1 3/8" PTO Conversion
Fits 600, 700, 800, 900, 601, 701, 801, 901, 2000-4000
4 Cylinder

C5NNA701K
PTO Shaft for 4 Speed Transmission
32.44" Long



Fits 2000, 3000, 3400

C5NNA728A
Replaces E5NNA728AA
Live PTO Shaft, 540 RPM
6 & 8 Speed Transmissions



Fits 2000, 3000, 2600, 3600, 231, 335, 531, 340, 540

D3NN710D
Replaces C5NN710A
PTO Shaft for Independent PTO
30.64" Long



Fits 4000, 4600, 4400, 4500, 445, 445A, 515, 535

D3NN710A
PTO Shaft for Transmission PTO
34.9" Long



Fits 4000, 4600, 4400, 4500, 445, 445A, 515, 535

D2NNN752C
PTO Shaft, Single Speed, 540 RPM
10.890" Long



Fits 5000, 5100, 5200, 700, 7100, 7200

E4NNN752AA
Replaces D2NNN752B
PTO Shaft, Single Speed, 540 RPM
12.030" Long



Fits 5000, 5100, 5200, 700, 7100, 7200

D2NNB728A
PTO Shaft, 2 Speed, 540 RPM



Fits 5000, 5100, 5200, 7000, 7100, 7200, 5600, 6600, 7600, 6700, 7700

E6NNB728AA
PTO Shaft, 2 Speed, 540 RPM



Fits 5610, 6610, 7610, 6710, 7710, 5640, 6640, 7740, 7840, 8240, 8340

E8NNB728BB
Replaces 83964339
PTO Output Shaft



Fits 3230, 3430, 3930, 4130, 4630, 4830, 5030



Ford / New Holland

PTO

314267

Replaces **81809581**
PTO Bearing Snap Ring



Fits 500, 600, 700, 800, 900, 501, 601, 701, 801, 901, 2000-4000 4 Cylinder, 2000, 3000, 4000, 4000SU, 2600, 3600, 4600, 4600SU, 2310, 2610, 2810, 2910, 3610, 3910, 4610, 3230, 3430, 3930, 4130, 4630, 4830, 5030, 340, 340A, 340B, 3400, 4400, 4500 231, 335, 420, 445, 445A, 445B, 445C, 445D, 515, 531, 532, 535, 540, 545A, 545B, 545C, 545D

46810

Replaces **310086F,**
80046810,
81864128, 86505465,
F0NN7R141B
PTO Snap Ring



Fits 500, 600, 700, 800, 900, 501, 601, 701, 801, 901, 2000-4000 4 Cylinder, 2000, 3000, 4000, 4000SU, 2600, 3600, 4600, 4600SU, 2310, 2610, 2810, 2910, 3610, 3910, 4610SU, 231, 335, 531, 340, 540, 3400, 3500, 445, 4500, 250C, 340, 340A, 340B, 345C, 345D, 445, 445A, 445C, 445D, 540, 540A, 540B, 545, 545A, 545C

E75GE9

Replaces **84330083, C5NN7118A,**
E3NND703AA, ST205A,
8A7065
PTO Bearing



Fits 500, 600, 700, 800, 900, 501, 601, 701, 801, 901, 2000-4000 4 Cylinder, 2000, 3000, 4000, 4000SU, 2600, 3600, 4600, 4600SU, 2310, 2610, 2810, 2910, 3610, 3910, 4610SU, 231, 335, 531, 340, 540, 3400, 3500, 445, 4500, 250C, 340, 340A, 340B, 345C, 345D, 445, 445A, 445C, 445D, 540, 540A, 540B, 545, 545A, 545C

D9NN703BA

Replaces **D9NN703BB,**
D8NN703AA
PTO Shaft Seal



Fits 2000, 3000, 4000, 4000SU, 2600, 3600, 4600SU, 2310, 2610, 2810, 2910, 3610, 3910, 4610, 340, 540, 3400, 3500, 445, 4500

D9NNN710DA

Replaces **D9NNN710CA**
PTO Shaft Seal



Fits 5000, 5100, 5200, 7000, 7100, 7200, 5600, 6600, 7600, 6700, 7700, 5610, 6610, 7610

E7NN797BA

Replaces **310087F,**
83964336
PTO Seal Sleeve



C5NN747A

Replaces **81801907,**
957E4129
PTO Gasket



Fits 500, 600, 700, 800, 900, 501, 601, 701, 801, 901, 2000-4000 4 Cylinder, 2000, 3000, 4000, 4000SU, 2600, 3600, 4600, 4600SU, 2310, 2610, 2810, 2910, 3610, 3910, 4610SU, 3230, 3430, 3930, 4130, 4630, 4830, 5030, 231, 335, 531, 340, 540, 3400, 3500, 445, 4500, 250C, 340, 340A, 340B, 345C, 345D, 445, 445A, 445C, 445D, 540, 540A, 540B, 545, 545A, 545C

310088

PTO Shaft Cover for
Dry Brake Tractors



Fits NAA, 2N, 8N, 9N, 600, 700, 800, 900, 601, 801, 2000-4000 4 Cylinder, 2000, 3000, 2600, 3600, 2310, 2610, 3610

C5NN726B

PTO Shaft Cover for
Tractors with Wet Brakes

Fits 4000, 4600, 4610, 5000, 5600, 5610, 6610, 7610 3550, 4500, 445



Call Us: 1 (800) 462-7335

PTO

Ford / New Holland

E0NN745AA

Double Gear
2 Speed PTO
20 & 41 Teeth



E0NNA726AD

Driven Gear
2 Speed PTO
70 Teeth, 540 RPM



E0NNA726BA

Driven Gear
2 Speed PTO
84 Teeth, 1000 RPM



Fits 5610, 5910, 6610, 6710, 7610, 7710, 5640, 6640, 7740, 7840, 8240, 8340

D3NNN883A

Replaces **D9NNN883AA, C7NNN883A, C7NN873A, D3NN873A**
Hydraulic Pump Drive Gear



Use With Housing **C9NN7049C** and **E0NN7049AA**, Will Not Work on **C5NN7049A** Housing.

Fits 5000, 5100, 5200, 7000, 7100, 7200, 5600, 6600, 7600, 6700, 7700, 5610, 6610, 7610, 6710, 7710

C5NN7A684A

PTO Drive Shaft
15 Spline

Fits 5000, 5100, 5200, 7000, 7100, 7200



E4NN7A684AA

PTO Drive Shaft
20 Spline

Fits 5000, 5100, 5200, 7000, 7100, 7200, 5600, 6600, 7600, 6700, 7700, 5610, 6610, 7610, 6710, 7710, 5640, 6640, 7740, 7840, 8240, 8340

E1NN7A684AB

PTO Drive Shaft for Synchronized Transmission
20 Spline

Fits 5610, 6610, 7610, 6710, 7710, 5640, 6640, 7740, 7840, 8240, 8340

C7NN7049D

Replaces **D9NN7N087A, C7NN7N085B**
Hyd Pump Idler Gear Support
(2.999" Bearing O.D.)



Fits 5000, 5100, 5200, 7000, 7100, 7200 01/01/1965-04/30/1971

C9NN7049C

Replaces **C9NN7N087B**
Hyd Pump Idler Gear Support
(2.890" Bearing O.D.)

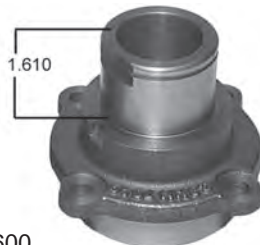

Fits (5000, 5100, 5200, 7000, 7100, 7200, All 05/01/1971 Up), 5600, 6600, 7600, 6700, 7700, 5610, 6610, 7610, 6710, 7710

E9NN7A684AA

Replaces **81862903**
PTO Drive Shaft



Fits 5610, 6610 (Both 11/91-, 8 Speed Non-Synchro), 5610S, 6610S, 7610S, 7810S, 7010, 8010, 5640, 6640, 7740, 7840, 8240, TB80, TB85, TB90, TB100, TB110, TB120, TS90, TS100, TS110 Where Used For E9NN7A684AA

Ford / New Holland

PTO

C5NNN777A

PTO Drive Plate
15 Spline

Fits 5000, 5100, 5200, 7000,
7100, 7200



E1NNN777AB

Replaces 83936827,
E1NNN777AA, E2NNN777AA
PTO Drive Plate
20 Spline

Fits 5000, 5100, 5200, 7000, 7100, 7200, 5600, 6600,
7600, 6700, 7700, 5610, 6610, 7610, 6710, 7710, 5640,
6640, 7740, 7840, 8240, 8340

D5NNN700A

Replaces 81844785,
83907423, 87764369,
D2NNN700A,
D3NNN700A
PTO Clutch Valve



Fits 5000, 5100, 5200, 7000, 7100, 7200 (06/01/1973 Up),
5600, 5700, 5900, 6600, 6700, 7600, 7700

D2NNN700B

Replaces 81827441,
C7NNN700C
PTO Valve



Fits 5000, 5100, 5200, 7000, 7100, 7200, (01/01/1965-
05/31/1973)

NDA701B

Replaces NDA702B
PTO Countershaft
Fits All 5 Speeds (1955-1964)



Fits 600, 700, 800, 900, 601, 701, 801, 901, 2000-4000
4 Cylinder

E0NNN700AD

Replaces 83955509
PTO Clutch Valve



Fits 5110, 5610, 5900, 6410, 6610, 6710, 6810, 7410,
7610, 7710, 7810, 7910, 8210

NCA717A

PTO Coupler



Fits 600, 700, 800, 900, 601, 701, 801, 901, 2000-4000
4 Cylinder

C5NNN783A

PTO Thrust Washer



313283

PTO Clutch Pack Sealing Ring
Used with D2NNN751D &
E0NNN751BA Clutch Pack



Fits 5000, 5100, 5200, 7000, 7100, 7200, 5600, 6600,
7600, 6700, 7700, 5610, 6610, 7610, 6710, 7710, 5640,
6640, 7740, 8000, 9000, 8600, 9600, 8700, 9700, TW5,
TW10, TW15, TW20, TW25, TW30, TW35

NAA722A

PTO Stop



Fits 8N, 9N, 2N, NAA, 500, 600, 700, 800, 900, 501, 601,
701, 801, 901, 2000-4000 4 Cylinder, 2000, 3000, 3400



Call Us: 1 (800) 462-7335

PTO

Ford / New Holland

E0NNB726AB

PTO Brake Band



Fits 5000, 7000, 5600, 6600, 7600, 7700, 5600, 6610, 7610, 7710, 8010, 5640, 6640, 7740, 7840, 8240, 8340

F1NNN750AA

Replaces **E0NNN750AA, D2NNN750A**

PTO Drive Hub with Gear
20 Teeth on Gear, 52 External Splines & 25 Internal Splines



Fits 5000, 5100, 5200, 7000, 7100, 7200, 5600, 6600, 7600, 6700, 7700, 5610, 6610, 7610, 6710, 7710

373227S

PTO Piston O-Ring Seal, Inner



C0NN7A548A

PTO Piston O-Ring Seal, Outer



Fit 5000, 5100, 5200, 7000, 7100, 7200, 5600, 6600, 7600, 6700, 7700, 5610, 6610, 7610, 6710, 7710

C9NNP743D

Replaces **D1NNP743A, D3NNP743A**
PTO Disc with Internal Teeth, Brass



Fits 5000, 5100, 5200, 7000, 7100, 7200, 5600, 6600, 7600, 6700, 7700, 5610, 6610, 7610, 6710, 7710

D2NNN751D

PTO Clutch Pack with 4 Discs

Fits 5000, 5100, 5200, 7000, 7100, 7200, 5600, 6600, 7600, 6700, 7700, 5610, 6610, 7610, 6710, 7710



PBB77573A

PTO Plate with External Splines, Steel



Fits 5000, 7000, 5600, 6600, 7600, 7700, 5600, 6610, 7610, 7710, 8010

E0NNN751BA

PTO Clutch Pack with 5 Discs

Fits 5000, 5100, 5200, 7000, 7100, 7200, 5600, 6600, 7600, 6700, 7700, 5610, 6610, 7610, 6710, 7710

C7NNN776C

PTO Support with Hole

Fits 5000, 5100, 5200, 7000, 7100, 7200



D2NNN776A

PTO Support without Hole

Fits 5600, 6600, 7600, 6700, 7700, 5610, 6610, 7610, 6710, 7710

E9NNN750AB

Replaces **81865535**
PTO Clutch Hub



Fits 5640, 6640, 7740, 7840, 8240, 8340, TB80, TB85, TB90, TB100, TB110, TB120, TS90, TS100, TS110, TS115, TV140, TV145, TV6070, 9030E, 9030V

C9NNN747A

PTO Brake Arm

Fits 4000, 4600, 3910, 4610

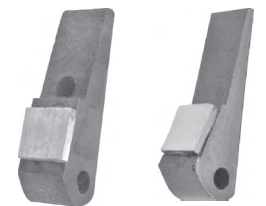

C9NNN747B

PTO Brake Arm

Fits 5000, 5100, 5200, 7000, 7100, 7200

Ford / New Holland

PTO

C7NNN740A

PTO Shifter



BB7234

PTO Shifter Spring



3709245

PTO Shifter Ball



C5NN720A

PTO Shifter Fork



C5NN723A

PTO Shifter Lever



C7NN721A

PTO Shifter Plate



Fits 2000, 3000, 2600, 3600, 2310, 2610, 2810, 2910, 3610

C5NN702A

PTO Countershaft
6 & 23 Spline, 12 1/8" Long



C7NN702B

Replaces **C5NN702B**
PTO Countershaft
6 & 11 Spline, 24" Long



Fits 2000, 3000, 4000, 2600, 3600, 4600, 2610, 2910, 3610, 2910, 4610

C5NN717A

PTO Coupler



C5NNN705A

PTO Coupler



Fit 2000, 3000, 2600, 3600, 2310, 2610, 2810, 2910, 3610

E8NN733AC

Replaces **83990098**,
E8NN733AB
PTO Cover



Fits 3230, 3430, 3930, 4130, 4630, 4830, 5030

E8NNB728BB

Replaces **83964339**
PTO Output Shaft



Fits 3230, 3430, 3930, 4130, 4630, 4830, 5030

E9NN702AB

Replaces **82847570**, **E9NN701AB**
PTO Countershaft Gear
33 Teeth, 29 Splines



Fits 3230, 3430, 3930, 4130, 4630, 4830, 5030

E9NNA727AB

Replaces **83983010**
PTO Drive Gear
30 Teeth, 29 Splines



Fits 3230, 3430, 3930, 4130, 4630, 4830, 5030

E9NNA726AA

Replaces **83982999**
PTO Drive Gear
33 Teeth, 27 Splines



Fits 3230, 3430, 3930, 4130, 4630, 4830, 5030



COOLING

Ford / New Holland

8N8005

Radiator



Fits 9N, 2N, 8N

957E8005

Radiator

Core Dimensions: 13 1/2" x 14 13/16"



Fits Dexta, Super Dexta from
1/1958-3/31/1962

C5NN8005AB

Replaces NCA8005C

Radiator



Fits NAA, 600, 700, 800, 900, 601, 701, 801, 901, 2000-4000 4 Cylinder

C7NN8005E

Radiator

Core Dimensions: 17.75" x 18"

Without Cooler



Fits 5000, 5100, 5200, 7000, 7100, 7200, 5600, 5900, 6600, 7600, 5610, 6610, 7610

E0NN8005MD15M

Radiator

Core Dimensions: 16" x 17.25"

Without Cooler

With Recess on Right Side for
Transmission Cooler Lines



Fits 2600, 3600, 4600SU, 2310, 2610, 2810, 2910, 3610, 3910, 4610, 231, 335, 531, 340, 340A, 340B, 540, 540A, 540B

C7NN8005H

Radiator

Core Dimensions: 16" x 17.375"

Without Cooler



Fits 2000, 3000, 4000, 4100, 4000SU, 2600, 3600, 4600SU, 2310, 2610, 2810, 2910, 3610, 3910, 4610, 231, 335, 531, 340, 340A, 340B, 540, 540A, 540B, 3400, 3500, 445, 4400, 4500

E0NN8005GC15M

Replaces E0NN8005GA

Radiator

Core Dimensions: 17.75" x 18.75"

With Cooler, Without AC



Fits 5000, 5100, 5200, 7000, 7100, 7200, 5600, 6600, 7600, 5610, 6610, 7610

D8NN8005PA

Radiator

Core Dimensions: 16" x 17.25"

With Cooler

Cooler Fittings on Grille Side



Fits 2000, 3000, 4100, 340, 340A, 340B, 540, 540A, 540B, 3400, 3500, 420, With Torque Converter, 445, 4400, 4500



Ford / New Holland

COOLING

D8NN8005SB

Radiator
Core Dimensions: 17.75" x 18"
With Cooler
Cooler Ports Face Engine Side



Fits 4500, 5000, 5100, 5200, 5600, 6600, 345C, 445C, 535, 545

D4NNH860A

Hydraulic/Trans Oil Cooler



Fits 2600, 3600, 4600, 5600, 6600, 7600, 231, 335, 531

E9NN8005AB15M

Radiator
Core Dimensions: 16" x 18"
Without Cooler
With Recess on Right Side for
Transmission Cooler Lines



Fits 3230, 3430, 3930, 4130, 4630

COOLING

Ford / New Holland

957E8260A
Upper Radiator Hose



957E8286
Lower Radiator Hose



Fits Dexta, Super Dexta

D5NN8260D
Upper Radiator Hose



Fits 2000, 3000, 4000, 5000, 7000, 2600, 3600, 4600, 5600, 6600, 7600

C5NN8286B
Lower Radiator Hose



Fits 2000, 3000, 4000, 2600, 3600, 4600

C5NN8286C
Lower Radiator Hose



Fits 5000, 7000, 5600, 6600, 7600

E2NN8100AA
Radiator Cap, 7 PSI



E2NN8100BA
Radiator Cap, 13 PSI

E0NN8575AA
Thermostat, 180° Fahrenheit



Fits 2000, 3000, 4000, 4000SU, 2600, 3600, 4600, 4600SU, 5000, 5100, 5200, 7000, 7100, 7200, 5600, 6600, 7600, 6700, 7700, 5610, 6610, 7610, 6710, 7710, 8000, 9000, 8600, 9600, 8700, 9700, TW5, TW10, TW15, TW20, TW25, TW30, TW35, 2310, 2610, 2810, 2910, 3610, 3910, 4610, 231, 335, 531, 340, 540, 3400, 3500, 445, 4500

C4AH10884A
Water Temperature Sending Unit, Small



Fits 2000, 3000, 4000, 5000, 7000, 2600, 3600, 4600, 5600, 5700, 6600, 7600, 7700 (1965-3/1976)

D5NN10884A
Water Temperature Sending Unit, Large



Fits 2600, 3600, 4600, 5600, 6600, 7600

C5NN8115B
Replaces C9NN8115B
Radiator Drain Cock



C7NN8594A
Thermostat Housing



Fits 2000, 3000, 4000, 4000SU, 5000, 7000, 2600, 3600, 4600, 4600SU, 5600, 6600, 7600, 7700, 2310, 2610, 2810, 2910, 3610, 3910, 4610SU, 5610, 6610, 7610, 7810, 5900, 3230, 3430, 3930, 4130, 4630, 4830, 5030, 5640, 6640, 7740, 7840, 8240, 8000, 9000, 8600, 9600, 9700, TW10, TW20, TW30, 231, 335, 531, 340, 540, 3400, 3500, 445, 4500, 250C, 340, 340A, 340B, 345C, 345D, 445, 445A, 445C, 445D, 540, 540A, 540B, 545, 545A, 545C, 545D, 550, 555, 555A, 555B, 555C, 655, 655A, 655B, 655C, 655D

C5NN8125A
Replaces B9NN8125A
Radiator Mounting Pad



Fits 8N, 9N, 2N, NAA, 500, 600, 700, 800, 900, 501, 601, 701, 801, 901, 2000-4000 4 Cylinder, 2000, 3000, 4000, 4000SU, 5000, 7000, 2600, 3600, 4600, 4600SU, 5600, 6600, 7600, 7700, 2310, 2610, 2810, 2910, 3610, 3910, 4610SU, 5610, 6610, 7610, 7810, 5900, 3230, 3430, 3930, 4130, 4630, 4830, 5030, 231, 335, 531, 340, 540, 3400, 3500, 445, 4500, 250C, 340, 340A, 340B, 345C, 345D, 445, 445A, 445C, 445D, 540, 540A, 540B, 545, 545A, 550, 555, 555A, 555B, 655, 655A, 655B

Ford / New Holland

COOLING

CDPN8501A

Water Pump with Pulley

Fits 2N, 8N, 9N



CDPN8501B

Water Pump with Pulley

Fits NAA 1953-54



DCPN8501A

Water Pump without Pulley

Fits NAA, 600, 700, 800, 900, 2000-4000
4 Cylinder



CDPN8501C

Water Pump with Pulley

Fits 2000, 4000, 600, 700, 800,
900 Gas and Diesel



957E8501B

Water Pump

Fits Dexta, Super Dexta



FAPN8A513GG

Replaces EAPN8A513F
Water Pump, Single Pulley



FAPN8A513DD

Water Pump, Double Pulley

Fits 2000, 3000, 4000, 4000SU, 2600, 3600, 4600,
4600SU, 5000, 5100, 5200, 7000, 7100, 7200, 5600, 6600,
7600, 6700, 7700, 5610, 6610, 7610, 6710, 7710, TW5,
TW10, TW15, TW20, TW25, TW30, TW35, 2310, 2610,
2810, 2910, 3610, 3910, 4610, 231, 335, 531, 340, 540,
3400, 3500, 445, 4500



FAPN8A513HH

Replaces 81863909
Water Pump
With Threaded Pulley



Fits 5110, 5610, 5610S, 5900, 6410, 6610, 6610S, 6710,
6810, 7610, 7610S, 7710

FAPN8A513LL

Water Pump with Pulley



Fits 8700, 9700, TW10, TW20, TW30, TW5, TW15, TW25,
TW35, 8210, 8530, 8630, 8730, 8830

87800714

Water Pump with Pulley



Fits 5640, 6640, TS90

D4NN10C318A

Fan Belt
For Tractors With Generators

Fits 2000, 3000, 4000, 4000SU,
5000, 5100, 5200, 7000, 7100,
7200

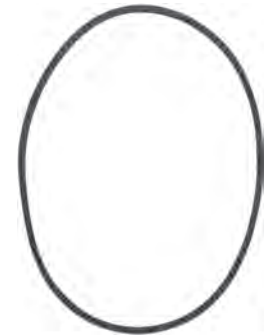

D3NN10C318C

Fan Belt
For Tractors With Alternators

Fits 2600, 3600, 4600, 4600SU, 5600, 6600, 7600



Call Us: 1 (800) 462-7335

COOLING

Ford / New Holland

D6NN8632A

Fan Bracket



Fits 8700, 9700

NCA8600S

3 Blade Fan



Fits 600, 700, 800, 900, 601, 701, 801, 901, 2000-4000
4 Cylinder

E6NN8A614AB

Replaces 83986807
Idler Pulley With Bracket



Fits 2600, 3600, 4600, 5600, 5610, 6600, 6610, 6700, 6710, 7600, 7700, 7710, 7810, 7910, 8210, 8530, 8630, 8700, 8730, 8830, 9700, TB90, TB100, TB110, TB120, TW5, TW10, TW15, TW20, TW25, TW30, TW35, 335, 340, 340A, 340B, 420, 445, 445A, 515, 531, 532, 535, 540, 540A, 540B, 545, 545A, 550, 555, 555A, 555B, 555C, 555D, 575D, 650, 655, 655A, 655B, 655C, 655D, 675D, 750, 755, 755A, 755B, 6500, 7500, A62, A64, A66



Ford / New Holland

ELECTRICAL

EHPN10849A

Replaces C5NN10849L
Gauge Assembly
For Tractors with Generator



Fits 2000, 3000, 4000, 5000, 7000, 3400, 3500, 4400, 4500

E5NN10849BA

Replaces D8NN10849TB
Gauge Assembly
For Tractors with Alternator



Fits 2600, 3600, 4600, 4600SU, 2310, 2610, 2810, 2910, 3610, 3910, 4610, 5600, 6600, 7600, 6700, 5610, 6610, 7610, 6710, 7710, 231, 335, 531, 340, 540, 445

E5NN10849DA

Replaces 83954555
Gauge Assembly



Fits 2310, 2610, 2910, 3610, 3910, 4110, 4610, 5610, 5610S, 6610, 6610S, 6810S, 7610, 7610S, 3230, 3430, 3930, 4130, 4630, 4830, 5030, 230A, 234, 334, 335, 340, 340A, 340B, 445A, 450, 540, 540A, 540B, 545, 545A

8N17360A1

Proof Meter
With Four Speed Transmission



Fits 8N

C3NN17360N

Proof Meter
With Four Speed Transmission



Fits NAA, 500, 600, 700, 800, 900, 2000 & 4000 4 Cylinder

C3NN17360K

Proof Meter
With Five Speed Transmission



Fits NAA, 500, 600, 700, 800, 900, 2000 & 4000 4 Cylinder

A0NN10670A

Replaces FAD10850A, 360053R91, 378424R91, 393334R91, 208302
Amp Gauge Chrome



Fits All Ford Models Prior to 1958; Massey Ferguson TO35, 35, 50, 65, 85, 165, Super 90; Case/IH Cub (to S/N 248125), Cub 184, 140 (to S/N 57724), 454, 464, 574, 674, 2400A, 2500A; Allis Chalmers B, C, D10, D12, D14, D15, D17, D19, D21, WC, WD45, WD45 Diesel, WF, 170, 190

9N9273A

Oil Pressure Gauge



Fits 9N, 2N, 8N

UTG25

Temperature Gauge
Adapter is 1/2" - 14 NPT
Probe is 5/8" - 18 thread
6' Cable



Fits Universal

ELECTRICAL

Ford / New Holland

A0NN10670A-B

Amp Gauge, Black



Fits NAA, 500, 600, 700, 800, 900, 501, 601, 701, 801, 901, 2000 and 4000

A0NN10670A

Replaces FAD10850A,
360053R91, 378424R91,
393334R91, 208302
Amp Gauge, Chrome



Fits 8N, 9N, 2N, NAA, 500, 600, 700, 800, 900, 501, 601, 701, 801, 901, 2000 and 4000

FAD9273A

Oil Pressure Gauge, Black



Fits NAA, 500, 600, 700, 800, 900, 501, 601, 701, 801, 901, 2000 and 4000

9N9273A

Replaces 506902M1, 9A550,
FAD9273A
Oil Pressure Gauge, Chrome



Fits 8N, 9N, 2N, NAA, 500, 600, 700, 800, 900, 501, 601, 701, 801, 901, 2000 and 4000

C3NN18287A

Temperature Gauge, Black



Fits NAA, 500, 600, 700, 800, 900, 501, 601, 701, 801, 901, 2000 and 4000

310949

Fuel Gauge 12VT, Black



Fits NAA, 500, 600, 700, 800, 900, 501, 601, 701, 801, 901, 2000 and 4000



Ford / New Holland

ELECTRICAL

8N17365

Tachometer Cable

Fits 8N



B9NN17365B

Replaces

B9NN17366B

Tachometer Cable

Fits NAA, 500, 600, 700, 800, 900, 501, 601, 701, 801, 901, 2000-4000 4 Cylinder

C7NN17365A

Tachometer Cable, 40"

Fits 2000, 3000, 4000, 4000SU, 3400, 3500

D3NN17365C

Replaces **D5NN17365D**

Tachometer Cable, 45.5"
with Q cab

Fits 6710, 7710, 5610, 6610, 7610

C7NN17365B

Replaces **D9NN17365AB**

Tachometer Cable, 49"

Fits 2600, 3600, 4600SU, 2310, 2610, 2810, 2910, 3610, 3910, 4610, 4000, 4600, 3910, 4610, 5610, 6610, 7610, 231, 335, 531, 340, 540, 445

D3NN17365F

Tachometer Cable, 47"

Fits 5600, 6600, 7600, 5610, 6610, 7610

F1NN17N275AA

Replaces **D3NN17N275A**

Tachometer Drive Wire



Fits 2600, 3600, 4600, 4600SU, 2310, 2610, 2810, 2910, 3610, 3910, 4610, 5600, 6600, 7600, 6700, 7700, 5610, 6610, 7610, 6710, 7710, 231, 335, 531, 340, 540, 445 with Alternator

F1NN17N264AB

Replaces **D3NN17N264B**

Tachometer Adapter



Fits 2600, 3600, 4600, 4600SU, 5600, 6600, 7600, 6700, 7700, 5610, 6610, 7610, 6710, 7710, 2310, 2610, 2810, 2910, 3610, 3910, 4610, 3230, 3430, 3930, 4630, 4830, 5030, 231, 335, 531, 340, 540, 445

C5NF17373B

Tachometer Drive Gear



C5NF17B282B

Tachometer Drive Assembly



Fits 2000, 3000, 4000, 4000SU, 5000, 5100, 5200, 7000, 7100, 7200



ELECTRICAL

Ford / New Holland

8NE10300ALT

Alternator Kit
For Front Mount Distributor

Fits 9N, 2N, 8N



8NL10300ALT

Alternator Kit
For Side Mount Distributor

Fits 8N

NAA10300ALT

Alternator Kit

Fits NAA

NCA10300ALT

Alternator Kit

Fits 500, 600, 700, 800, 900, 501, 601, 701, 801, 901,
2000-4000 4 Cylinder

E7NN10B376AB

Replaces 82857207,
E3NN10B376AD,
E7NN10B376BB
Alternator



Fits 3230, 3430, 3930, 4130, 4630, 4830, 5030, 7610S,
7810S, 8010S, 250C, 260C, 345C, 345D, 545C, 545D,
555C, 555D, 655C, 655D, 575D, 675D

82010242

Replaces F2NN10B376AA,
F0NN10B376BB,
F0NN10B376BA
Alternator



Fits TS90, TS100, TS110

SBA185046071

Replaces SBA185046150
Alternator



Fits 1000, 1500, 1600, 1700, 1900

82001260

Replaces F2NN10B376CA,
F0NN10B376AA
Alternator
70 Amp



Fits 5640, 6640, 7740, 7840, 8340, 8440, LS190, LX985

D5NN10300D

Alternator
51 Amp



Fits 2600, 3600, 4600, 4600SU, 5600, 6600, 7600, 6700,
7700, 2810, 2910, 3610, 3910, 4610, 5610, 6610, 7610,
6710, 7710, 8000, 8600, 9000, 9600, 9700, TW5, TW10,
TW20, TW30, 231, 335, 531, 340, 540, 445, 515, 250C

Ford / New Holland

ELECTRICAL

8N10000BLPR

Replaces 8N10000B
Generator Single Terminal
For Tractors With
Front Mount Distributor



Fits 9N, 2N, 8N

C3NF11002C

Starter Ford
4 Cylinder Gas and Diesel
6VT and 12VT



Fits NAA, 600, 700, 800, 900, 601, 701, 801, 901,
2000-4000 4 Cylinder

ADN10001R

Replaces ADN10001
Generator



Fits Dexta, Super Dexta, Major, Super Major

D7NN11001AR

Starter Ford
For Gas Engines



Fits 2000, 3000, 4000, 5000, 7000, 2600, 3600, 4600,
4600SU, 2310, 2610, 2810, 2910, 3610, 3910, 4610, 5600,
6600, 7600, 6700, 7700, 5610, 6610, 7610, 6710, 7710,
3400, 3500, 4400, 4500, 231, 335, 531, 340, 540, 445

C7NN10000C

Generator with Tach Drive
Without Pulley



Fits 2000, 3000, 4000, 5000, 7000, 3400, 3500, 4400,
4500, 5500, 6500, 7500

D8NN11000CE

Starter Ford
For Diesel Tractors



Fits 2000, 3000, 4000, 4000SU, 2600, 3600, 4600,
4600SU, 5000, 5100, 5200, 7000, 7100, 7200, 5600, 6600,
7600, 6700, 7700, 5610, 6610, 7610, 6710, 7710, TW5,
TW10, TW15, TW20, TW25, TW30, TW35, 2310, 2610,
2810, 2910, 3610, 3910, 4610, 231, 335, 531, 340, 540,
3400, 3500, 445, 4500

SBA185086052

Starter



Fits 1000, 1500, 1600, 1700

82005342

**Replaces 82005343,
82007917, 82012413,
82013922,**
Starter Ford



Fits 3230, 3430, 3930, 4630, 4830, 5030, 5610S, 6610S,
7610S, 5640, 6640, 7010, 7740, 7840, 7840, 8010, 8240,
8340, 8360, 8560, 8160, 8260, TS90, TS100, TS110,
TS115, TB100, TB110, TB120, TM115, TM120, TM125,
TM130, TM135, TM140, TM150, TM155, TM165, TM175,
TM190, LB75, LB115, LB110, LS865, LS885, HW300,
HW320, HW340, 2450, 2550, 5855, 675, L783, L783, L785,
L785, L865, L885, LS180, LS190, LX865, LX885, 555,
LX985

8N11001R

Starter Ford



Fits 9N, 2N, 8N



ELECTRICAL

Ford / New Holland

8N11450
Starter Relay
6 Volt



Fits 9N, 2N, 8N

NCA11450A
Starter Relay
6 Volt



Fits NAA, 500, 600, 700, 800, 900, 501, 601, 701, 801, 901, 2000-4000 4 Cylinder

311006
Starter Relay
12 Volt



Fits 500, 600, 700, 800, 900, 501, 601, 701, 801, 901, 2000-4000 4 Cylinder

E4NN11390AC
Starter Solenoid



Fits 2000, 3000, 4000, 4000SU, 2600, 3600, 4600, 4600SU, 5000, 5100, 5200, 7000, 7100, 7200, 5600, 6600, 7600, 6700, 7700, 5610, 6610, 7610, 6710, 7710, 8000, 9000, 8600, 9600, 8700, 9700, TW5, TW10, TW15, TW20, TW25, TW30, TW35, 5600, 6600, 7600, 2310, 2610, 2810, 2910, 3610, 3910, 4610, 231, 335, 531, 340, 540, 3400, 3500, 445, 4500

D7NN11390A
Replaces D0NN11K134A,
D4NN11390B
Starter Solenoid



Fits 2000, 3000, 4000, 5000, (1965 and Up), 3900, 4100, 4600, 5600, 6600, 7600, 7700 (Diesel with 5" starter, 1975 and Up)

D8NN11350BA
Replaces
5211350C,
ECON11350C
Starter Drive



Fits 9N, 2N, 8N



Ford / New Holland

ELECTRICAL

TUKFD01

Tune Up Kit
For Tractors With Front Mount
Distributor

Contains Ignition Kit, Spark Plugs,
Plug Wires, and Distributor Cap
For Individual Parts Order Below



ATK6FFR

Ignition Kit With Rotor



AL437

Spark Plug



SWS259

Spark Plug Wire Set



9N12106C

Distributor Cap
For Front Mount Distributor



Fits 9N, 2N, 8N

TUKFD03

Tune Up Kit

Contains Ignition Kit, Spark Plugs,
Plug Wires, and Distributor Cap
For Individual Parts Order Below



ATK6FXR

Ignition Kit With Rotor



AL405

Spark Plug



DHPN12259A

Plug Wire Set



C5NF12106A

Distributor Cap



Fits 2000, 3000, 4000, 2600, 3600, 4600, 3400, 3500,
4100, 4200, 4400, 4500

TUKFD02

Tune Up Kit
For Tractors With Side Mount
Distributor

Contains Ignition Kit, Spark Plugs,
Plug Wires, and Distributor Cap
For Individual Parts Order Below



ATK7FFR

Ignition Kit With Rotor



AL216

Spark Plug



SWS259

Spark Plug Wire Set



NCA12106A

Distributor Cap
For Side Mount Distributor



Fits 8N, NAA, 600, 700, 800, 900, 601, 701, 801, 901,
2000-4000 4 Cylinder



ELECTRICAL

Ford / New Holland

9N12024

6-Volt Coil, Front Mount Distributor



9N1202412

12-Volt Coil, Front Mount Distributor

Fits 9N, 2N, 8N

9N12104

Distributor Gasket Set
For Front Mount Distributors



Fits 9N, 2N, 8N

D4PE12029AA

Ignition Coil



Fits (8N, 9N, 2N Side Mount Distributor), NAA, 600, 700, 800, 900, 601, 701, 801, 901, 2000-4000 4 Cylinder, 2000, 3000, 4000, 4000SU, 2600, 3600, 4600, 4600SU, 2310, 2610, 2810, 2910, 3610, 3910, 4610

9N12100

Distributor
Front Mount Type



Fits 9N, 2N, 8N

16-RU12

Resistor

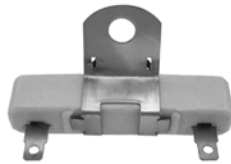

Fits Universal

FAC12127D

Distributor
Slot Type Drive



Fits NAA Golden Jubilee

FAA12239A

Dust Cap
For Side Mount Distributor



Fits 8N, NAA, 600, 700, 800, 900, 601, 701, 801, 901, 2000-4000 4 Cylinder

86588846

Distributor
Hex Type Drive
For 4 Cylinder Engines



Fits 500, 600, 700, 800, 900, 501, 601, 701, 801, 901, 2000-4000 4 Cylinder

8N12213

Rotor Spring
For Side Mount Distributor



Fits 8N, NAA, 600, 700, 800, 900, 601, 701, 801, 901, 2000-4000 4 Cylinder

F0NN12100AA

Replaces C7NF12127D,
F1NN12100AA

Distributor
For 3 Cylinder Engines



Fits 2000, 3000, 4000, 2600, 3600, 2610, 2810, 2910, 3610, 3910, 4600, 3400, 3500, 4500, 334, 335, 340, 340A, 445, 445A, 515, 530, 530A, 540, 540A, 545, 545A, 550, 555, 555A, 555B, 655, 655A

9N12150

Breaker Plate With Points
For Front Mount Distributors



Fits 9N, 2N, 8N



Ford / New Holland

ELECTRICAL

8N11500WG

Starter Switch



Fits 8N, NAA, 600, 700, 800, 900, 601, 701, 801, 901, 2000-4000 4 Cylinder

8N3679C

Key Switch



Fits 9N, 2N, 8N, NAA, 600, 700, 800, 900, 601, 701, 801, 901, 2000-4000 4 Cylinder

C7NN7A247A

Neutral Safety Switch



Fits 2000, 3000, 4000, 5000, 7000, 2600, 3600, 4600, 5600, 6600, 6700, 7600, 7700, 2310, 2610, 3610, 3910, 4610, 5610, 6610, 7610, 7810, 8000, 8200, 8210, 8400, 8530, 8600, 8830, 9000, 9200, 9600, TW5, TW15, TW25

E7NN11N501AB

Replaces **C5NN11N572A**,
D5NN11N572A, **D1NN11603B**
Starter and Heater Switch, 7 Terminals



D3NN11N501A

Replaces **D5NN11N501A**,
E8NN11N501AA
Starter Switch without Heater



Fits 2000, 3000, 4000, 5000, 7000, 2600, 3600, 4600, 5600, 6600, 6700, 7600, 7700, 2310, 2610, 3610, 3910, 4610, 5610, 6610, 7610, 7810, 8000, 8200, 8210, 8400, 8530, 8600, 8830, 9000, 9200, 9600, TW5, TW15, TW25

D0NN10505A

Voltage Regulator



Fits 2000, 3000, 4000, 4000SU, 5000, 5100, 5200, 7000, 7100, 7200, 8000, 9000, 8600, 9600, 3400, 3500, 4500

D1NN11603B

Replaces **C5NN11N570A**
Ignition Switch Key



Fits 2000, 2110, 2120, 2150, 2300, 230A, 231, 2310, 233, 234, 2600, 2600V, 2610, 2810, 2910, 3000, 3010S, 3055, 3110, 3120, 3150, 3230, 3300, 3310, 333, 3330, 334, 335, 340, 3400, 340A, 340B, 3430, 3500, 3550, 3600, 3600V, 3610, 3830, 3910, 3930, 4010S, 4030, 4110, 4130, 4140, 420 Loader, 4230, 4330, 4330V, 4400, 4410, 4430, 445 Diesel, 445 Gas, 445A, 450, 4500, 455C Loader, 455D, 4600, 4600SU, 4610, 4630, 4830, 5000, 5030, 5110, 515, 530A, 531, 532, 5340, 535 Loader, 540, 540A, 540B, 545, 545A, 5600, 5610, 5610S, 5700, 5900, 6000, 6410, 6600, 6610, 6610S, 6700, 6710, 6810, 6810S, 7000, 7010, 7410, 7600, 7610, 7610S, 7700, 7710, 7810, 7810S, 7910, 8010, 8210, 8530, 8630, 8730, 8830, TC25, TC25D, TC29, TC29D, TC33, TC33D, TL100, TL70, TL80, TL90, TN55, TN55D, TN55S, TN65, TN65D, TN65F, TN65S, TN70, TN75, TN75D, TN75F, TN75S, TN90, TN90F, TW15, TW25, TW35, TW5

C5NE9A436A

Glow Plug



Fits 2000, 3000, 4000, 5000, 7000, 2600, 3600, 4600, 4600SU, 2310, 2610, 2810, 2910, 3610, 3910, 4610, 5600, 6600, 7600, 6700, 7700, 5610, 6610, 7610, 6710, 7710, 3400, 3500, 4400, 4500, 231, 335, 531, 340, 540, 445



ELECTRICAL

Ford / New Holland

310066
Headlight
6 Volt



Fits 8N, 9N, 2N, NAA, 600, 700, 800, 900

310068
Headlight
12 Volt



Fits 9N, 2N, 8N, NAA, 600, 700, 800, 900, 601, 701, 801, 901, 2000-4000 4 Cylinder, 2000, 3000, 4000, 4000SU, 2600, 3600, 4600, 4600SU, 5600, 6600, 7600, 2310, 2610, 2810, 2910, 3610, 3910, 4610, 4000, 4600, 3910, 4610, 5000, 5100, 5200, 7000, 7100, 7200, 6700, 7700, 5610, 6610, 7610, 6710, 7710, 3230, 3430, 3930, 4130, 4630, 4830, 5030, 3400, 4400, 4500 231, 335, 420, 515, 531, 532, 535, 540, 545, 250C, 345C

C5NN14A103AF

Wiring Harness,
Front and Rear
For Tractors with Generators



Fits 2000, 3000, 4000, 4000SU,
3400, 3500, 4500 US Tractors

C9NN14A103B

Wiring Harness, Front
For Tractors with Alternators
and Fuse Boxes Only

C5NN14N104R

Wiring Harness, Rear
For Tractors with Alternators
and Fuse Boxes Only

Fits 2600, 3600, 4600SU, 231, 335, 531, 445

C9NN14A103C

Wiring Harness, Front
For Tractors with Alternators
and Fuse Boxes Only

C9NN14N104B

Wiring Harness, Rear
For Tractors with Alternators
and Fuse Boxes Only

Fits 5600, 6600, 7600

Ford / New Holland

AIR CLEANERS

D8NN9661AA

Replaces **D0NN9661B**,
D1NN9661A, **D5NN9661A**,
D8NN9661BA

Air Cleaner Cover Assy



Fits 2600, 3600, 4600, 5600, 5700, 6600, 6700, 7600,
7700, 230A, 231, 234, 334, 335, 340A, 340B, 530A, 531,
540A, 540B

C5NE9661A

Air Cleaner Cover



Fits 2000, 3000, 4000, 2600, 2600, 2600, 2310, 2610,
2901, 3610, 3910, 4610 All Gas, 3400, 4400, 4500, 231,
335, 420, 515, 531, 532, 535, 540, 545 Gas and Diesel

C5NN9A660B

Air Cleaner Cap 2" Diameter



C5NN9A660A

Air Cleaner Cap 2 1/4" Diameter

Fits 5000, 5100, 5200, 7000, 7100, 7200, 5600, 6600,
7600

C0NN9A663A

Pre-Cleaner Bowl
7 1/4" Diameter



C9NN9A663A

Pre-Cleaner Bowl
10 1/2" Diameter

Fits All Models

C0NN9A660A

Pre-Cleaner Assembly
7.25" Bowl, 2.25" Pipe



Fits 4000, 5000, 7000, 2600, 3600, 4600,
5600, 6600, 6700, 2310, 2610, 3610, 3910,
4610, 5610, 6610

PC7-2.25

Pre-Cleaner Assembly
7" Bowl, 2.25" Mount



PC7-2.50

Pre-Cleaner Assembly
7" Bowl, 2.50" Mount



PC10-3

Pre-Cleaner Assembly
10" Bowl, 3" Mount

PC10-3.5

Pre-Cleaner Assembly
10" Bowl, 3.5" Mount

PC10-4

Pre-Cleaner Assembly
10" Bowl, 4" Mount

PC10-4.5

Pre-Cleaner Assembly
10" Bowl, 4.5" Mount



C5NN9B640B

Air Cleaner Hose Lower



Fits 2000, 3000, 4000 Diesel

C5NE9600F

Oil Bath Air Cleaner
With 2" Diameter Inlet

Fits 2000, 3000, 2600, 3600

C5NE9600E

Replaces **81806283**
Oil Bath Air Cleaner
With 2 1/4" Diameter Inlet

Fits 4000, 5000, 5100, 5200



FUEL

Ford / New Holland

8N9510C

Carburetor



Fits 9N, 2N, 8N

13875

Replaces TSX813

Carburetor
2 3/4" Mounting Bolt Distance. For 172 CI engines after S/N 126524. Has 7/16" bolt hole where fuel bowl assembly mounts on carburetor.



Fits 801, 901, 4000 4 Cylinder

B2NN9510A

Replaces TSX428, EAE9510C, 13879, 13880

Carburetor
2 1/4" center to center on mounting bolts. Uses fuel tank mounted fuel bowl.



Fits NAA, NAB, Golden Jubilee

13913

Replaces Holley Carburetor D6NN9510A, C7NN9510B, D8NN9510AA, C9NN9510A

Carburetor
For 3 Cylinder Engines



Fits 2000, 2600 with 158 CI Engines

B4NN9510A

Replaces TSX580, EAE9510D, 13879, 13880

Carburetor
2 1/4" center to center on mounting bolts. For 134 CI engines. Uses carburetor mounted fuel bowl.



Fits 500, 600, 700

13914

Replaces Holley Carburetor C7NN9510C, D3NN9510B, C9NN9510B, D6NN9510B, D8NN9510BA, D3NN9510C, D8NN9510CA

Carburetor
For 3 Cylinder Engines



Fits 3000, 3600 with 175 CI Engines

312954

Replaces TSX765, TSX593, TSX706, 13877, 13878

Carburetor
2 3/8" center to center on mounting bolts. For 134 CI engines. Uses carburetor mounted fuel bowl.



Fits 601, 701, 800, 900, 2000 4 Cylinder

13881

Replaces TSX769

Carburetor
2 3/4" Mounting Bolt Distance. For 172 CI engines before S/N 126524. Has 3/8" bolt hole where fuel bowl assembly mounts on carburetor.



Fits 801, 901

13912

Replaces Holley Carburetor C7NN9510A, C9NN9510C, C5NN9510N

Carburetor
For 3 Cylinder Engines



Fits 4000, 4600 with 201 CI Engines

Ford / New Holland

FUEL

C546V

Replaces C545V, C546

Carburetor Kit
For TSX241 and
TSX33 Carburetors

Fits 9N, 2N, 8N



C547V

Carburetor Kit
For TSX428, TSX580 EAE9510C,
and EAE9510D Carburetors

Fits NAA/Jubilee, 500, 600, 700,
800 1953/1957 With 134 CI Engine



C547AV

Carburetor Kit
For EAF9510G Carburetors

Fits 800, 900 1955-1957 With
172 CI Engine



C547BV

Replaces C547, C547B

Carburetor Kit
For TSX593, TSX706
and TSX765 Carburetors

Fits 501, 601, 701, 801, 901, 1958-
1962, 2000 4 Cylinder,
1962-1964 With 134 CI Engine



C547CV

Replaces C547C

Carburetor Kit
For TSX679, TSX769, and TSX813,
C0NN9510C, 312955 Carburetors

Fits 801, 901 1958-1962, 4000 4
Cylinder 1961-1964 With 172 CI Engine



CKPN9590A

Replaces HCK01

Carburetor Kit
For Holley Carburetors R3657 and R3656
With Separate Pump Gasket

Fits 2000, 3000, 4000



CKPN9590B

Replaces HCK02

Carburetor Kit
For Holley Carburetors R4119,
R4120, R855, R4111

With Integral Pump Gasket

Fits 2000, 3000, 4000, 4000SU, 2600, 3600, 4600, 2310,
2610, 2810, 2910, 3610, 3910, 4610, 231, 335, 531, 340,
540, 3400, 3500, 445, 4500



9N9550A

Float
For Small Carburetors

Fits 9N, 2N, 8N, NAA, 500, 600, 700, 501, 601,
701, 2000 4 Cylinder With 134 CI Engine



311608

Float
For Large Carburetors

Fits 800, 900, 801, 901, 4000 4 Cylinder
With 172 CI Engine



9N9553

Fuel Strainer Elbow

Fits 9N, 2N, 8N, NAA, 500, 600, 700, 800, 900, 501, 601,
701, 801, 901, 2000-4000 4 Cylinder



81811646

Replaces C5NN9740A

Throttle Rod Connector
Made From Plastic



Fits 2000, 3000, 4000, 4000SU, 5000, 7000, 2600, 3600,
4600, 4600SU, 5600, 6600, 7600, 7700, 2310, 2610, 2810,
2910, 3610, 3910, 4610SU, 5610, 6610, 7610, 7810, 5900,
5640, 6640, 7740, 7840, 8240, 8000, 9000, 8600, 9600,
9700, 231, 335, 531, 340, 540, 3400, 3500, 445, 4500,
250C, 340, 340A, 340B, 345C, 345D, 445, 445A, 445C,
445D, 540, 540A, 540B, 545, 545A, 545C, 545D, 550, 555,
555A, 655, 655A





FUEL

Ford / New Holland

2NAA9155B

Fuel Bowl Assembly

Fits 9N, 2N, 8N, NAA, 600



C0NN9155A

Sediment Bowl
Mounts to Carburetor and
has 7/16" Opening



311292

Fuel Tap with O-Ring

C0NN9285A

Fuel Tap
Lever Shut Off Type

Fits 500, 600, 700, 800, 900, 501, 601, 701, 801, 901, 2000-4000 4 Cylinder



NCA99180A

Fiber Washer
For 172 CID engines after SN 126524
For 7/16" bolt



C0NN9A349B

Fuel Bowl Bolt
7/16-20" x 1.50" for 172 CI Engine



Fits 801 Series, 901, 4000 4 Cylinder

E2NN9N024AA

Fuel Tap

Fits 2000, 3000, 4000, 4000SU, 2600, 3600, 4600, 4600SU, 5000, 5100, 5200, 7000, 7100, 7200, 5600, 6600, 7600, 6700, 7700, 5610, 6610, 7610, 6710, 7710, 8000, 9000, 8600, 9600, 8700, 9700, TW5, TW10, TW15, TW20, TW25, TW30, TW35, 2310, 2610, 2810, 2910, 3610, 3910, 4610, 231, 335, 531, 340, 540, 3400, 3500, 445, 4500



9N9002

Fuel Tank

Fits 9N, 2N, 8N



NAA9002E

Fuel Tank

Fits NAA, 600, 700, 800, 900, 601, 701, 801, 901, 2000-4000 4 Cylinder



957E9189C

Fuel Primer Pump

Fits Dexta, Super Dexta



311272

Fuel Bowl Assembly
For 134 CI engines and 172 CI
Engines Before S/N 126524. Has 3/8"
Bolt Hole. Mounts On Carburetor



NCA99180B

Fiber Washer
For 134 CID engines & 172 CID engines
before SN 126524. For 3/8" bolt



86531362

Replaces 313382
Fuel Bowl Bolt
3/8 24" x 1 7/16" for 134 CI Engine

Fits 500, 600, 700, 800, 900, 501, 601, 701, 801, 901, 2000-4000 4 Cylinder



C5NN9002AC

Fuel Tank
For Tractors with Two Arm
Steering Sectors

Fits 2000, 3000, 4000, 4000SU,
2600, 3600, 4600SU, 2310,
2610, 2810, 2910, 3610, 3910,
4610



E2NN9002BA

Fuel Tank
For Tractors With One Arm Steering Sectors

Fits 4000, 4600, 3910, 4610, 340, 540, 445, 4500

D8NN9002HA

Fuel Tank

Fits 5000, 5100, 5200, 7000, 7100, 7200, 5600, 6600,
7600, 5610, 6610, 7610



Ford / New Holland

FUEL

C5NN9N283A

Fuel Tank Lock Ring
Also Works On Most
Aftermarket Fuel Tanks



Fits 2000, 3000, 4000, 5000, 7000,
2600, 3600, 4600, 5600, 5700, 6600,
6700, 7600, 7700, 2610, 2910, 3610,
2910, 4610, 5610, 6610, 7610, 7710

C5NE9165C

Fuel Filter Assy, Single



Fits 2000, 3000, 4000, 5000, 7000, 2600, 3600, 4600,
5600, 5700, 6600, 6700, 7600, 7700

E1ADDN9030

Fuel Cap

Fits Dexta and Major



E7NN9030AA

Replaces **C5NN9030B**

Fuel Cap

Fits Most Ford Models 1965 Up

C7NN9165C

Fuel Filter Assy with Glass Bowl, Single



Fits 2000, 3000, 4000, 5000, 7000, 2600, 3600, 4600,
5600, 5700, 6600, 6700, 7600, 7700

310940

Fuel Sending Unit
12 Volt, 8.75"



Fits NAA, 500, 600, 700, 800, 900, 501, 601, 701, 801,
901, 2000 and 4000 4 Cylinder

EBPN9N166AA

Fuel Filter Assy, Dual



Fits 2000, 3000, 4000, 5000, 7000, 2600, 3600, 4600,
5600, 5700, 6600, 6700, 7600, 7700, 2610, 2910, 3610,
2910, 4610, 5610, 6610, 7610, 7710

C5NN9A316B

Replaces **D8NN9A316KA**

Fuel Sending Unit



Fits 2000, 2600, 3000, 3600,
4000, 4600, 2610, 3610, 3910, 4110, 4610

EDPN9N074AA

Replaces **7111/296**

Fuel Filter



Fits 2000, 3000, 4000, 5000, 7000, 2600, 3600, 4600,
5600, 5700, 6600, 6700, 7600, 7700, 2610, 2910, 3610,
2910, 4610, 5610, 6610, 7610, 7710

C5NN9A316A

Replaces **D8NN9A316JA**

Fuel Sending Unit

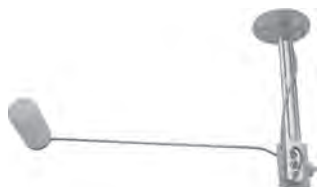

Fits 5000, 5600, 6600, 7600,
5610, 6610, 7610

D1NN9K024A

Fuel Filter Drain Plug



Fits All Ford 1965 Up



FUEL

Ford / New Holland

F2NN9350AA

Replaces C5NE9350A

Fuel Pump For Gas Engines

Fits 2000, 3000, 4000, 4000SU, 2600, 3600, 4600, 4600SU, 5000, 5100, 5200, 5600, 6600, 2810, 2910, 3610, 3910, 4610, 231, 335, 531, 340, 540, 3400, 3500, 445, 4500



3233F661

New Injection Pump
For 158 CI Engines



Fits 2000, 2600

957E9350B

Fuel Pump

Fits Dexta and Super Dexta



3233F380

New Injection Pump
For 175 CI Engines



D8NN9350AB

Fuel Lift Pump

Fits 3000, 5000, 7000, 5600, 6600, 6700, 7600, 7700, 5610, 6610, 7610, 7710



Fits 3000, 3600, 3400, 335

F1NN9A384BA

Replaces 81874144

Fuel Primer Pump



Fits 230A, 2310, 234, 250C, 260C, 2610, 2610V, 2810, 2910, 3230, 334, 335, 3430, 3610, 3610V, 3910, 3910H, 3910N, 3910R, 3910V, 3930, 3930H, 3930N, 3930NO, 4110, 4110N, 4110NO, 4110O, 4110V, 4130, 4130N, 4130NO, 445C, 4610, 4610N, 4610NO, 4610SU, 4610V, 4630, 4630N, 4630NO, 4630O, 4830, 4830N, 4830O, 5030, 5030O, 5110, 530A, 545C, 545D, 555C, 555D, 5610, 575D, 5900, 6410, 655C, 655D, 6610, 6610O, 6710, 675D, 6810, 7410, 755B, 7610, 7610O, 7710, 9030V, L781, L783, L785, L865, L885, LX865, LX885, 345C, 345D

INJPUMP02

New Injection Pump
For 192 and 201 CI Engines



Fits 4000, 4000SU, 4600, 4600SU, 231, 335, 531, 340, 540, 3400, 3500, 445, 4500, 550, 555, 555A, 555B

F1NN9A384AA

Replaces 81866602

Fuel Filter Head/Primer Pump



Fits 6610S, 7610S, 7810S, 5640, 6640, 7740, 7840, 8240, 8340, TB80, TB85, TB90, TH100, TB110, TB120

3249F951

Replaces D3NN9A543F, D4NN9A543F

New Injection Pump
For 220 and 256 CI Engines



Fits 6600, 6610, 6710

Ford / New Holland

FUEL

7135-110

Injection Pump Repair Kit
For CAV DPA Style Pumps

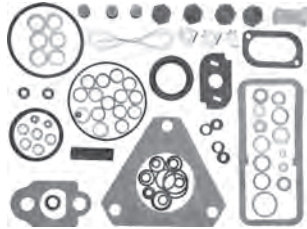

7123-388

Transfer Pump Blade Kit
For CAV DPA Style Pumps



5393-252U

Seal
For CAV Injection Pump Drive Hub
For CAV DPA Style Pumps



7123-287

Replaces **C5NE9C568A,**
9917923

Inj Pump Top Cover Gasket
For CAV Injection Pumps
For CAV DPA Style Pumps



E6NN9F598AA

Replaces **83959395, C5NE9F598A**
Injection Pump Mounting Cover Gasket
For Timing Cover
For CAV DPA Style Pumps



380426S

Sealing Washer
For Top Cover
For CAV DPA Style Pumps



568-010

O-Ring
For Top Cover Lever Shafts
For CAV DPA Style Pumps



Fits CAV DPA Style Pumps 2000, 3000, 4000, 4000SU, 5000, 7000, 2600, 3600, 4600, 4600SU, 5600, 6600, 7600, 7700, 2310, 2610, 2810, 2910, 3610, 3910, 4610SU, 5610, 6610, 7610, 7810, 5900, 231, 335, 531, 340, 540, 3400, 3500, 445, 4500, 250C, 340, 340A, 340B, 345C, 345D, 445, 445A, 445C, 445D, 540, 540A, 540B, 545, 545A, 545C, 545D, 550, 555, 555A, B, C, 655, 655A, B, C, D

7123-515A

Replaces **C7NN9G579A,**
E0NN9G579AA

Inj Pump Side Cover Gasket
For CAV Injection Pumps



E0NN9G578AA

Injection Pump Cover Plate
For CAV Injection Pumps



Fits 2000, 3000, 4000, 4000SU, 2600, 3600, 4600, 4600SU, 5600, 6600, 7600, 2310, 2610, 2810, 2910, 3610, 3910, 4610, 5000, 5100, 5200, 7000, 7100, 7200, 5610, 6610, 7610, 231, 335, 531, 340, 540, 3400, 3500, 445, 4500

E1ADDN993184

Injection Pump Drive Disc



Fits Major, Super Major

C9NN9A579C

Head and Rotor



Fits 3 Cylinder CAV Pumps

E8NN9D278AA

Replaces **83981012**
Electric Fuel Stop Solenoid



Fits 276V, 3230, 3430, 3930, 4130, 4630, 4830, 5030, 5110, 5610S, 6610S, 6810S, 7610S, 7810S, 7840, 8010, 8240, 8340, 9030, TB80, TB90, TB100, TB110, TB120, TS90, TS100, TS110, TS115, 250C, 260C, 345C, 345D, 445C, 445D, 455C, 455D, 545C, 545D, 555C, 555D, 655C, 655D, 575D, 575E, 655E, 675D, 675E, 755B, L783, L765, L785, LX865, LX885, LS180, LS190, LB75, LB110, LB115



FUEL

Ford / New Holland

D0NN9F593A

Replaces C5NE9F593B, C5NE9F593C, C5NE9F593CRDS, C5NE9F595A, C7NN9F593B, D0NN9F593ARDS, D9NN9F593DA
Injector



Fits Ford 2000, 3000, 4000, 5000, 5100, 5200, 5500, 5550, 8000, 3400, 3500, 3550, 4400, 4500

D9NN9F593BA

Replaces 501934, 81834304, 82845284, 83916913, 83918029, 83948208, 83959021, C7NN9F593B, D4NN9F593AR, D4NN9F593BR, D4NN9F595A, D5NN9F593AR, D8NN9F593DB, D9NN9E527AA, D9NN9E527CA, D9NN9F593AA, D9NN9F593DA, E1NN9E527BA, E2NN9F593AA, E2NN9F593AAR, E4NN9F593BA, E6NN9F593AA, E6NN9F593BB, E6NN9F593GA
Injector



Fits Ford 2310, 2610, 2910, 3610, 3910, 4610, 5610, 6610, 7810, 7910, 8210, 8530, 8730, 8830, TW5, TW15, TW25, TW35, 230A, 234, 530A

D4NN9F593A

Replaces D4NN9F593ARDS, D8NN9F593DB, D8NN9F593DBRDS, D9NN9F593DA, E4NN9F593CA
Injector



Fits Ford 2600, 3600, 4600, 5600, 5700, 6600, 6700, 8600, 8700, TW10, 230A, 231, 234, 334, 335, 340A, 340B, 530A, 531, 540A, 540B

E6NN9F593BA

Replaces C9NN9F593B, C9NN9F593BRDS, C9NN9F595A, D4NN9F593C, D8NN9F593BA, D8NN9F593DB, D9NN9F593CA, D9NN9F593CARDS
Injector



Fits 7000, 7600, 7700, 7610, 7710, 9000, 9700, TW20, TW30, TW35

E7NN9F593CA

Replaces 83964126
Injector

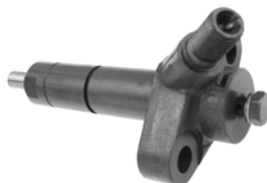

Fits 4630 Turbo, 4830, 5030, 5110, 5610, 6610, 6710, 5900, 6410, 6810, 7410, 555C, 555D, 575D, 655C, 655D, LX865, LX885

C5NE9F596A

Seal Kit



Fits Ford Injectors 1965 and Up

E9NN9F593CA

Replaces 83982447
Injector



Fits 3230, 3430, 3930, 4130, 4630, 250C, 260C, 345C, 345D, 445C, 445D, 455C, 355D, 545C, 545D, L781, L783, L785

Ford / New Holland

FUEL

Fuel Injector Lines

C5NE9A555D

1 Injector Line

C5NE9A556D

2 Injector Line

C5NE9A557E

3 Injector Line



Fits 3 Cylinder Engines with CAV Fuel Injection Pump

C5NE9A555F

1 Injector Line

C5NE9A556F

2 Injector Line

C5NE9A557G

3 Injector Line

C5NE9A558B

4 Injector Line

Fits 5000, 7000 with Simms Fuel Injection Pump

D9NN9A555BA

1 Injector Line

D9NN9A556BA

2 Injector Line

D9NN9A557BA

3 Injector Line

D9NN9A558AA

4 Injector Line

Fits 5600, 6600, 7600, 7700, 5610, 6610, 7610, 7710
With CAV Fuel Injection Pump

D9NN9A555DA

1 Injector Line

D9NN9A556DA

2 Injector Line

D9NN9A557DA

3 Injector Line

D9NN9A558CA

4 Injector Line

Fits 5600, 6600, 7600, 7700, 5610, 6610, 7610, 7710
With Simms Fuel Injection Pump

Flexible Fuel Lines

Replace Steel Fuel Lines Easily



2500

Fuel Line 14" Long

2501

Fuel Line 16" Long

2502

Fuel Line 31.5" Long

2503

Fuel Line 22.5" Long

2504

Fuel Line 32.5" Long

2505

Fuel Line 38" Long

2506

Fuel Line 41.5" Long

C5NE9E529A

Injector Sealing Washer



Fits All Ford 1965 Up



E5NN9C331EA

Fuel Stop Cable Assy
56", Round Knob

C5NN9C331G

Fuel Stop Cable Assy
50", Round Knob

E5NN9C331DB

Fuel Stop Cable Assy
63", Round Knob

D5NN9C331A

Fuel Stop Cable Assy
50", Square Knob

C5NN9C331H

Fuel Stop Cable Assy
45", Round Knob

D5NN9C331B

Fuel Stop Cable Assy
45", Square Knob

HYDRAULICS, HYDRAULIC PUMPS

Ford / New Holland

8N605A
Hydraulic Pump



Fits 8N

D0NN600F
Hydraulic Pump
Transmission Mounted



Fits 3500, 4000, 4100, 4200, 4400, 4500

NCA600F
Hydraulic Piston Pump



Fits NAA, 600, 700, 800, 900, 601, 701, 801, 901,
2000-4000 4 Cylinder

D8NN600LB
Hydraulic Pump
For Non-Synchronized Transmission



Fits 3900, 4100, 4600, 2810, 2910,
3910, 4110, 4610, 3230, 3420, 3930,
4130, 4630, 4830, 5030, 420, 445, 445A, C, D, 515, 532,
535, 540, 540A, B, 545, 545A, C, D

C5NN600AA
Hydraulic Pump
Piston Type
With Flanged Lines



Fits 2000, 3000, 4000, 4000SU, 2600, 3600, 4600,
4600SU, 2310, 2610, 2810, 2910, 3610, 3910, 4610SU,
231, 335, 531, 340, 540, 3400, 3500, 445, 4500, 340,
340A, 340B, 445, 445A, 531, 542, 540, 540A

E9NN600BC
Hydraulic Pump
For Synchronized Transmission



Fits 3230, 3420, 3930, 4130, 4630, 4830, 5030

C7NN600Y
Hydraulic Pump
With Push In and 15/16"
Screw In Line



Fits 2000, 3000, 4000, 4000SU, 2600, 3600, 4600,
4600SU, 2310, 2610, 2810, 2910, 3610, 3910, 4610SU,
231, 335, 531, 340, 540, 3400, 3500, 445, 4500, 340,
340A, 340B, 445, 445A, 531, 542, 540, 540A

E8NN600AA
Hydraulic Pump
Transmission Mounted for
8 x 8 Transmission



Fits 250C, 260C, 345C, 345D, 445C, 445D, 545C, 545D

D6NN600A
Hydraulic Pump
With Push In and 3/4"
Screw In Line



Fits 2600, 3600, 4600, 2310, 2610, 3610, 4610, 230, 231,
335, 340, 340A, 420, 445, 515, 530A, 531, 532, 535, 540,
540A, 545

D0NN600G
Hydraulic Pump Without Dual Power



D2NN600B
Hydraulic Pump With Dual Power

E1NN600AA
Replaces **E1NN600AB,**
E2NN600AB
Hydraulic Pump Engine Mounted



Fits 2600, 3600, 2310, 2610, 2810, 3610, 5610, 6610,
7610, 6710, 7710

E7NN915BA
Replaces **C5NN915A**
Hydraulic Pump Gasket



Fits 5000, 5100, 5200, 7000, 7200

Ford / New Holland

HYDRAULICS, HYDRAULIC PUMPS

D8NN600KB

Hydraulic Pump
Transmission Mounted



D4NNB483A

Replaces **D3NNB483A**
Hydraulic Pump Gasket



Fits 5600, 6600, 7600, 6700, 7700

E0NN600AC

Hydraulic Pump
Transmission Mounted



E0NNB483AB

Hydraulic Pump Gasket



Fits 5610, 6610, 7610, 6710, 7710

F0NN600BB

Hydraulic Pump
Transmission Mounted



Fits 5640, 6640, 7740, 7840, 8240, 8340

F0NN600AA

Auxiliary Hydraulic Pump
Without Gear



Fits 5640, 6640, 7740, 7840, 8240, 8340

D5NN600C

Hydraulic Pump
Transmission Mounted



Fits 8000, 8600, 8700, 9000, 9600, 9700

E2NN600BA

Hydraulic Pump



Fits TW30, TW35

D8NN600FA

Hydraulic Pump



Fits TW5, TW10, TW15, TW20, TW25

5179726

Hydraulic Pump



Fits TL70, TL80, TL80A, TL90, TL90A, TL100, TM115, TM120, TM125, TM130, TM140, TN55, TN55D, TN55S, TN60A, TN65, TN65D, TN65F, TN65S, TN70, TN70A, TN70D, TN70F, TN70S, TN75, TN75D, TN75F, TN75S, TN75SA, TN80F, TN85, TN85A, TN90, TN90F, TN95A, TN95F, 4835, 5635, 6635, 7635, 8160, 8260, 8360

D8NN600AA

Replaces **85700189**,
E7NN600CA, **E7NN600BB**,
E7NN600BA

Hydraulic Pump
Loader Backhoe



Fits 340, 340A, 340B, 445, 445A, 540, 540A, 540B, 545A, 545, 550, 555, 555A, 555B, 555C, 555D, 655A, 655B, 655C, 655D

D1NN600B

Hydraulic Pump
Loader Backhoe



Fits 4500, 535, 550

HYDRAULICS, HYDRAULIC PUMP PARTS

Ford / New Holland

9N640
Control Valve



Fits 9N, 2N

9N617A
Hydraulic Pump Cam Block



Fits 9N, 2N, 8N

8N638
Hydraulic Pump Safety Valve



Fits 9N, 2N, 8N

9N636
Valve Chamber Plug



Fits 9N, 2N, 8N

9N621
Valve Chamber, R/H
Without Valves



9N622
Valve Chamber, L/H
Without Valves

Fits 9N, 2N, 8N

VALVEKIT01
Valve Chamber Repair Kit



Fits 9N, 2N, 8N

9N621WV
Valve Chamber, R/H
With Valves



9N622WV
Valve Chamber, L/H
With Valves

Fits 9N, 2N, 8N

PUMPKIT01
Hydraulic Pump Repair Kit

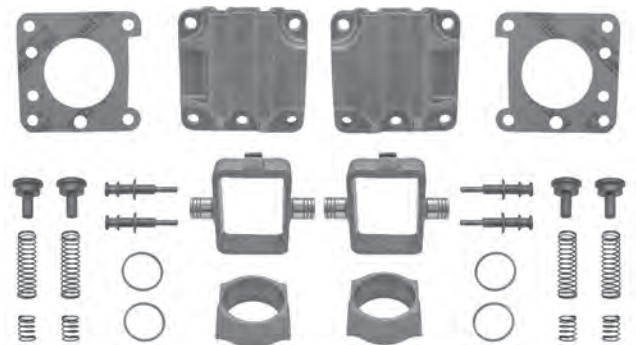

Fits 9N, 2N, 8N

9N615
Hydraulic Pump Piston



Fits 9N, 2N, 8N



Ford / New Holland

HYDRAULICS, HYDRAULIC PUMP PARTS

NCA905C

Hydraulic Pump Gear Housing
For Piston Type Pump



Fits NAA, 500, 600, 700, 800, 900, 501, 601, 701, 801, 901, 2000-4000 4 Cylinder

312059

Replaces NCA893A
Cover & Pin Assy
For Piston Hydraulic Pumps



Fits NAA, 500, 600, 700, 800, 900, 501, 601, 701, 801, 901, 2000-4000 4 Cylinder

NCA966E

Hydraulic Pump Shaft



Fits NAA, 500, 600, 700, 800, 900, 501, 601, 701, 801, 901, 2000-4000 4 Cylinder

311142

Hydraulic Pump Body
Uses 5/8" pistons.
If replacing 9/16" pistons,
order 6 NCA615C pistons.



Fits NAA, 500, 600, 700, 800, 800, 501, 601, 701, 801, 901, 2000-4000 4 Cylinder

C3NN908A

Hydraulic Pump Gear



Fits NAA, 500, 600, 700, 800, 900, 501, 601, 701, 801, 901, 2000-4000 4 Cylinder

C5NN615A

Hydraulic Pump Piston
9/16" Diameter



Fits 2000, 3000, 4000, 3400, 3500, 3550, 4500, 2600, 3600, 4600, 230, 231, 335, 340, 340A, 420, 445, 515, 530A, 531, 532, 535, 540, 540A, 545

EAF951A

Proof Meter Bolt



Fits NAA, 500, 600, 700, 800, 900, 501, 601, 701, 801, 901, 2000-4000 4 Cylinder

NCA615C

Hydraulic Pump Piston
5/8" Diameter



Fits NAA, 600, 700, 800, 900, 601, 701, 801, 901, 2000-4000 4 Cylinder, 2000, 3000, 4000, 4000SU, 2600, 3600, 4600, 4600SU, 2310, 2610, 2810, 2910, 3610, 3910, 4610SU, 231, 335, 531, 340, 540, 3400, 3500, 445, 4500, 250C, 340, 340A, 340B, 345C, 345D, 445, 445A, 445C, 445D, 540, 540A, 540B, 545, 545A, 545C

EAF17375D

Proof Meter Adapter



Fits NAA, 500, 600, 700, 800, 900, 501, 601, 701, 801, 901, 2000-4000 4 Cylinder

EAF17381A

Proof Meter Drive Bushing



Fits NAA, 500, 600, 700, 800, 900, 501, 601, 701, 801, 901, 2000-4000 4 Cylinder

CCPN600AB

Hydraulic Pump Rebuild Kit
For Piston Pump

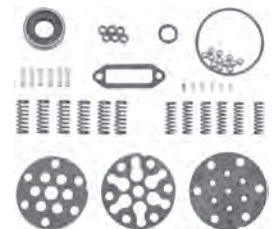

Fits NAA, 500, 600, 700, 800, 900, 501, 601, 701, 801, 901, 2000-4000 4 Cylinder



HYDRAULICS, HYDRAULIC PUMP PARTS

Ford / New Holland

C5NN966A
Hydraulic Pump Shaft



C5NN877B
Hydraulic Pump Gear Housing
For Piston Type Pump



C5NNN880A
Hydraulic Pump
Drive Gear



C5NN908A
Hydraulic Pump
Driven Gear



314075
Idler Gear Thrust Washer



C5NN872A
Hydraulic Pump Idler Gear Shaft
For Piston Hydraulic Pump



Fits 2000, 3000, 4000, 4000SU, 2600, 3600, 4600, 4600SU, 2310, 2610, 2810, 2910, 3610, 3910, 4610SU, 231, 335, 531, 340, 540, 3400, 3500, 445, 4500, 340, 340A, 340B, 445, 445A, 531, 542, 540, 540A

169024
Hydraulic Pump
Drive Shaft Bearing



C5NNN900A
Hydraulic Pump
Idler Shaft Bearing



C5NN851A
Hydraulic Pump Seal
For Piston Pump



C5NN885A
Hydraulic Pump Seat
For Piston Hydraulic Pumps
(packed and priced as a pack of six)



CKPN600A
Hydraulic Pump
Rebuild Kit
For Piston Pump

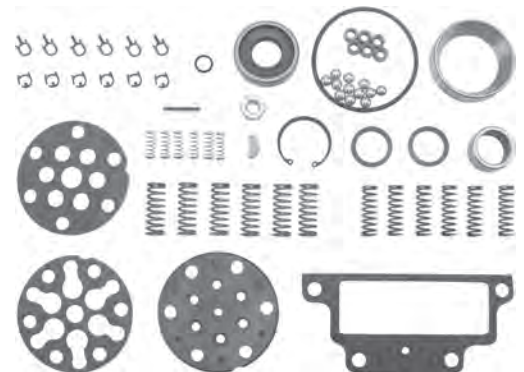

Fits 2000, 3000, 4000, 4000SU, 2600, 3600, 4600, 4600SU, 2310, 2610, 2810, 2910, 3610, 3910, 4610SU, 231, 335, 531, 340, 540, 3400, 3500, 445, 4500, 340, 340A, 340B, 445, 445A, 531, 542, 540, 540A



Ford / New Holland

HYDRAULICS, HYDRAULIC PUMP PARTS

C7NN882C

Hydraulic Pump Body
For Push in Style Lines.
Uses 5/8" pistons.
If replacing 9/16" pistons,
order 6 NCA615C pistons.



Fits 2000, 3000, 4000, 3400, 3500, 3550, 4500, 2600,
3600, 4600, 2310, 2610, 3610, 4610, 230, 231, 335, 340,
340A, 420, 445, 515, 530A, 531, 532, 535, 540, 540A, 545

D4NN893A

Cover & Pin Assy
1975 Up, 3/4" Threaded Hole
For Piston Hydraulic Pumps



Fits 2600, 3600, 4600, 2310, 2610, 3610, 4610, 230, 231,
335, 340, 340A, 420, 445, 515, 530A, 531, 532, 535, 540,
540A, 545

C5NN882C

Hydraulic Pump Body
For flange type lines.
Uses 5/8" pistons.
If replacing 9/16" pistons,
order 6 NCA615C pistons.



Fits 2000, 3000, 4000, 3400, 3500, 3550, 4500,
1/1965-9/1969

C5NN615A

Hydraulic Pump Piston
9/16" Diameter



Fits 2000, 3000, 4000, 3400, 3500, 3550, 4500, 2600,
3600, 4600, 230, 231, 335, 340, 340A, 420, 445, 515,
530A, 531, 532, 535, 540, 540A, 545

NCA615C

Hydraulic Pump Piston
5/8" Diameter



C5NN893B

Cover & Pin Assy
1/1965-9/1969, Flange Type
For Piston Hydraulic Pumps



Fits 2000, 3000, 4000, 3400, 3500, 3550, 4500, 6000

C0NN858A

Replaces NCA858A
Hydraulic Pump Roller

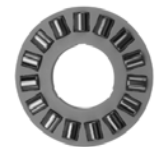

C0NN859A

Replaces NCA859A
Wobble Plate



C7NN893C

Cover & Pin Assy
10/1969 Up, 15/16" Threaded Hole
For Piston Hydraulic Pumps



Fits 2000, 3000, 4000, 3400, 3500, 3550, 4500

Fits NAA, 600, 700, 800, 900, 601, 701, 801, 901, 2000-
4000 4 Cylinder, 2000, 3000, 4000, 4000SU, 2600, 3600,
4600, 4600SU, 2310, 2610, 2810, 2910, 3610, 3910,
4610SU, 231, 335, 531, 340, 540, 3400, 3500, 445, 4500,
250C, 340, 340A, 340B, 345C, 345D, 445, 445A, 445C,
445D, 540, 540A, 540B, 545, 545A, 545C

HYDRAULICS, HYDRAULIC PUMP PARTS

Ford / New Holland

FPN910B

Hydraulic Pump Gasket Set
For Piston Style Hydraulic
Pumps with 9/16" or 5/8"
Pistons Only. Not for use
with 1/2" diameter pistons.



Fits NAA, 500, 600, 700, 800, 900, 501, 601, 701, 801,
901, 2000-4000 4 Cylinder

EAF911B

Hydraulic Pump Gasket
For Piston Style Hydraulic Pump



NAA17382A

Hydraulic Pump Gasket
For Piston Style Hydraulic
Pump



Fits NAA, 500, 600, 700, 800, 900, 501, 601, 701, 801,
901, 2000-4000 4 Cylinder

C0NN869A

Replaces **82849229**
Hydraulic Pump Gasket
For Piston Style Hydraulic
Pump

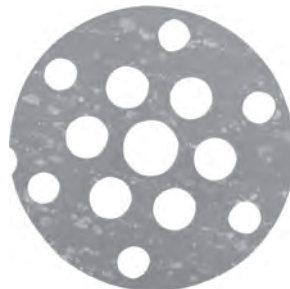

D6NN867A

Replaces **81815300,**
83908691, C5NN867A
Hydraulic Pump Gasket
For Piston Style Hydraulic
Pump

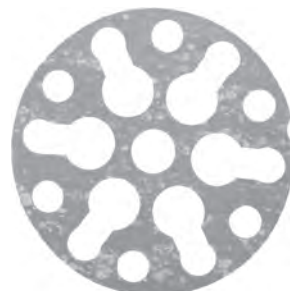

Fits NAA, 500, 600, 700, 800, 900, 501, 601, 701, 801,
901, 2000-4000 4 Cylinder, 2000, 3000, 4000, 2600,
3600, 4600, 2310, 2610, 3610, 4610, 230A, 231, 3400,
3500, 4400, 4500, 335, 445



Call Us: 1 (800) 462-7335

Ford / New Holland

HYDRAULICS, LIFT COVER

LCRK01

Lift Cover Repair Kit
For Tractors 1965-1975
3" Bore

Fits 2000, 3000, 3400

LCRK02

Lift Cover Repair Kit
For Tractors 1965-1975
3.250" Bore

Fits 4000, 4400

LCRK03

Lift Cover Repair Kit
For Tractors 1965-1975
3.375" Bore

Fits 5000, 7000

LCRK04

Lift Cover Repair Kit
3.500" Bore

Fits 4600, 2810, 2910, 3610, 3910, 4610, 3230, 3430,
3930, 4130, 4330, 4630, 4830, 5030, 445A, 445B, 445C,
445D, 340, 340A, 340B, 345C, 345D, 540, 540A, 540B,
545, 545C, 545D

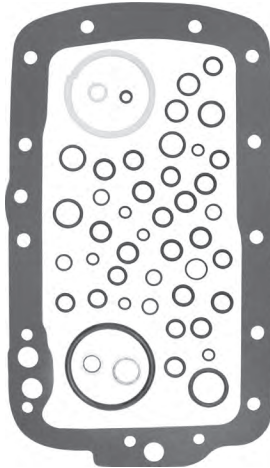

NAA530B

Hydraulic Piston O-Ring Type

Fits 2N, 9N, 8N, NAA



9N510D

Hydraulic Lift Cylinder

Fits 2N, 8N, 9N



C7NNN853B

Hydraulic Return Tube

Fits 3000



C9NN960A

Back Pressure Valve

Fits 2000, 3000, 4000, 5000, 7000, 2600, 3600, 4600,
5600, 5700, 6600, 6700, 7600, 7700, 2610, 2910, 3610,
2910, 4610, 5610, 6610, 7610, 7710



C5NN477B

Hydraulic Cylinder
With Valves and Piston
3" Bore

Fits 2000, 3000, 3400



957E984B

Replaces 81717252
Safety Valve

Fits 500, 600, 700, 800, 900, 501, 601, 701, 801, 901, 2000
and 4000 4 Cylinder, 2000, 3000, 4000, 4000SU, 2600,
3600, 4600, 4600SU, 2310, 2610, 2810, 2910, 3610, 3910,
4610, 231, 335, 531, 340, 540, 3400, 3500, 445, 4500
Dexta, Super Dexta



D3NN477E

**Replaces E0NN477BA,
E0NN477BB**
Hydraulic Cylinder
3" Bore

Fits 2600, 3600, 2310, 2610, 2910,
3610, 230, 231, 335, 340



C5NNN832B

Hydraulic Filter

Fits 2000, 3000, 4000, 4000SU, 2600, 3600, 4600,
4600SU, 5600, 6600, 7600, 6700, 7700, 231, 335, 515,
531, 340, 540, 3400, 3500, 445, 4500



C5NNN843A

Replaces 81802027
Oil Return Tube Bolt



Fits 5000, 5100, 5200, 7000, 7100, 7200, 5900

C5NNN832C

Hydraulic Filter

Fits 5000, 5100, 5200, 7000, 7100, 7200,
5900, Major, Super Major



HYDRAULICS, LIFT COVER

Ford / New Holland

NCA545B

Hydraulic Lift Ram Arm

Fits 600, 700, 800, 900, 501, 601, 701, 801, 901, 2000-4000 4 Cylinder



D1NN473A

Piston Seal Backup Ring

C5NN533A

O-Ring for Piston

Fits 3550, 4000, 4400, 4500



D3NND943B

Position Handle
For 2 lever Lift Top



D3NNB505B

Draft Handle
For 2 lever Lift Top

Fit 2600, 3600, 4600



DBPN531A-SEAL

Rockshaft Seal
Seal Only



DBPN531A

Rockshaft Bushing Set
With Seal

Fits 2000, 3000, 2600, 3600, 2310, 2610, 2810, 2910, 3610, 3910, 231, 335, 531, 340, 540, 3400, 3500



C7NN512B

Replaces 957E541A2
Quadrant Lever

Fits 2000, 3000, 4000, 5000, 7000



E2NN531AA

Replaces C5NN531A
Rockshaft Bushing



C5NNC944A

Rockshaft Seal

Fits 5000, 5100, 5200, 7000, 7100, 7200, 5600, 6600, 7600, 6700, 7700, 5610, 6610, 7610, 6710, 7710, 5640, 6640, 7740, 7840, 8240, 8340



C5NN475B

Hydraulic Blank Off Plate

Fits 2000, 3000, 4000, 5000, 7000, 2600, 3600, 4600, 5600, 5700, 6600, 6700, 7600, 7700, 2610, 2910, 3610, 2910, 4610, 5610, 6610, 7610, 7710



9N543B

Rockshaft Arm, R/H & L/H
Fits 9N, 2N, 8N, NAA



C5NNB920D

Rockshaft Arm, R/H

C5NNB921D

Rockshaft Arm, L/H

Fits 2000, 3000, 2600, 3600



C5NNN901A

Replaces 957E7010
Filler Plug

Fits 2000, 3000, 4000, 4000SU, 5000, 7000, 2600, 3600, 4600, 4600SU, 5600, 6600, 7600, 7700, 2310, 2610, 2810, 2910, 3610, 3910, 4610SU, 5610, 6610, 7610, 7810, 5900, 3230, 3430, 3930, 4130, 4630, 4830, 5030, 5640, 6640, 7740, 7840, 8240, 8000, 9000, 8600, 9600, 9700, TW5, TW10, TW15, TW20, TW25, TW30, TW35, 231, 335, 531, 340, 540, 3400, 3500, 445, 4500, 250C, 340, 340A, 340B, 345C, 345D, 445, 445A, 445C, 445D, 540, 540A, 540B, 545, 545A, 545C, 545D, 550, 555, 555A, B, C, 655, 655A, B, C, D

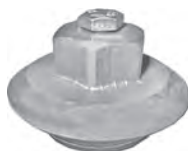

D3NNB920A

Rockshaft Arm, R/H

D3NNB921A

Rockshaft Arm, L/H

Fits 3900, 4100, 4600, 2810, 2910, 3610, 3910, 4610, 3230, 3430, 3930, 4630, 4830, 5030, 250C, 345C, 345D, 420, 450, 515, 532, 535, 540, 540B, 545, 545A, 545B, 545C, 545D





Ford / New Holland

HYDRAULICS, Misc

NAA876A

Hydraulic Line Set
For Piston Pumps



Fits NAA Golden Jubilee

C5NNN933Y

Hydraulic Line set



Fits 2000, 3000, 3400 01/01/1965-09/30/1969

NCA945B

Hydraulic Pressure Tube
For 4 Speed Transmissions



NDA945B

Hydraulic Pressure Tube
For 5 Speed Transmissions



NCA941C

Replaces NDA941C, 310838
Hydraulic Intake Tube
For 4 and 5 Speed Transmissions



Fits 600, 700, 800, 900, 601, 701, 801, 901,
2000-4000 4 Cylinder

D0NNB835A

Hydraulic Inlet Suction Line

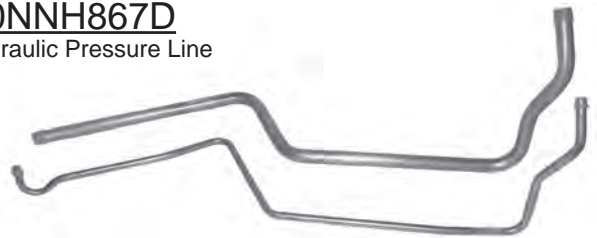

Fits 2000, 3000, 3400 10/01/1969 Up

D3NNB835R

Hydraulic Return Line
For Gear Pump



D4NNE897B

Hydraulic Pressure Line
For Gear Pump



Fits 2600, 3600

D4NNH978B

Hydraulic Sleeve
From Hydraulic Cylinder to Oil Cooler Bypass Valve



Fits 5000, 5100, 5200, 7000, 7100, 7200, 5600, 6600,
7600, 7700

C7NNH856C

Hydraulic Pump Pressure Nut
For Piston Pumps



C7NNE883A

Hydraulic Tube Elbow



Fits 2000, 3000, 4000, 2600, 3600, 4600

HYDRAULICS, MISC

Ford / New Holland

D8NNB486CA

Replaces D6NNB486A,
D8NNB486EA,
83912256, 83912298
Hydraulic Filter



Fits 2600, 3600, 4100, 4600, 5600, 6600, 6700,
7600, 2310, 2610, 2810, 2910, 3610, 3910, 4610, 4610SU,
5610, 6610, 7610, 7810, 7910, 8010, 8210, 3230, 3430,
3930, 4630, 4830, 5030, 8530, 8630, 8730, 8830, T1510,
TB100, TB110, TB120, TW5, TW15, TW25, TW35, 230A,
231, 233, 333, 335, 345C, 345D, 445A, 445C, 445D, 531,
532, 535, 540, 540A, 540B, 545, 545A, 545C, 545D

81871195

Replaces 83991164,
E9NNR947CA,
E9NNR947CB
Lift Unload Priority Valve
Less Deluxe Remotes



Fits 5110, 5610, 5900, 6410, 6610, 6710, 6810, 7610, 7710
(Less Deluxe Remotes) 5640, 6640, 7740, 7840, 8240,
8340 (Less EDC, Less Deluxe Remotes) TB80, TB85,
TB90, TB100, TB110, TB120 (With Deluxe Remotes) TS90,
TS100, TS110, TS115 (All With Emissionised Engines)

REMOTEKIT03

Single Hydraulic Remote Kit

Fits 2000, 3000, 2600,
3600, 2310, 2610, 3610



REMOTEKIT02

Single Hydraulic Remote Kit

Fits 5000, 7000, 5600, 6600, 7600

E9NNR947BB

Replaces 81871206,
47552380,
E9NNR947BA
Lift Unload Priority Valve
With Deluxe Remotes



Fits 5110, 5610, 5900, 6410, 6610, 6710, 6810, 7610, 7710
(With Deluxe Remotes) 5640, 6640, 7740, 7840, 8240,
8340 (With Deluxe Remotes) TB80, TB85, TB90, TB100,
TB110, TB120 (With Deluxe Remotes) TS90, TS100,
TS110, TS115 (All With Emissionised Engines)

C9NND912A

Replaces 81821946
Pivot Bolt



Fits 2000, 3000, 4000, 4000SU, 2600, 3600, 4600,
4600SU, 2310, 2610, 2810, 2910, 3610, 3910, 4610SU,
231, 335, 531, 340, 540, 3400, 3500, 445, 4500, 250C,
340, 340A, 340B, 345C, 345D, 445, 445A, 445C, 445D,
540, 540A, 540B, 545, 545A, 545C

E9NNR964AB

Replaces 81875778
Coupling, L/H



E9NNR963AB

Replaces 81875777
Coupling, R/H



HV4902

Valve Plate Kit



Fits 600, 700, 800, 900, 601, 701, 801, 901, 2000-4000
4 Cylinder, 2000, 3000, 4000, 4000SU, 2600, 3600, 4600,
4600SU, 5600, 6600, 7600, 3400, 4400, 4500 231, 335,
420, 515, 531, 532, 535, 540, 545

Fits 2310, 2610, 2810, 2910, 3610, 3910, 4610, 4610SU,
5610, 5610S, 6610, 6610S, 6810, 6810S, 7610, 7610S,
7810, 7810S 7910, 8010, 8210, 3230, 3430, 3930, 4630,
4830, 5030, 8530, 8630, 8730, 8830, 5640, 6640, 7740,
7840, 8240, 8340, 8160, 8260, 8360, 8560, 8630, 8730,
8830, TW5, TW15, TW25, TW35, TS90, TS100, TS110,
TS115

Ford / New Holland

HITCH

9N555B

Lower Lift Arm
CAT I



Fits 9N, 2N, 8N, NAA

C5NN556AF

Lower Lift Arm, L/H
CAT I



Fits 600, 700, 800, 900, 601, 701, 801, 901, 2000 & 4000 4
Cylinder, 2000, 3000, 2600, 3600, 2310, 2610, 2910, 3610

C5NN555AN

Lower Lift Arm, R/H
CAT I



E5NN556AA

Lower Lift Arm, L/H
Cat I on Tractor End,
Cat II on Implement End



Fits 2000, 3000, 4000, 4000SU, 2600, 3600, 4600,
4600SU, 2310, 2610, 2810, 2910, 3610, 3910, 4610SU,
231, 335, 531, 340, 540, 3400, 3500, 445, 4500, 250C,
340, 340A, 340B, 345C, 345D, 445, 445A, 445C, 445D,
540, 540A, 540B, 545, 545A, 545C

E5NN555AA

Lower Lift Arm, R/H
Cat I on Tractor End,
Cat II on Implement End



C7NN555SL

Lower Lift Arm, L/H
One Piece Type CAT II



Fits 4000, 4600, 3910, 4610

C7NN555SR

Lower Lift Arm, R/H
One Piece Type CAT II



D2NN555E

Lower Lift Arm, L/H
One Piece Type CAT II



D2NN555D

Lower Lift Arm, R/H
One Piece Type CAT II



Fits 5000, 5100, 5200, 7000, 7100, 7200, 5600, 6600,
7600, 6700, 7700, 5610, 6610, 7610

82002013

Lower Lift Arm
R/H or L/H
37.5" Center to Center CAT II



Fits 5000, 5100, 5200, 7000, 7100, 7200, 5600, 6600,
7600, 6700, 7700, 5610, 6610, 7610

83998746

Replaces F0NNC878AA

Lift Link End, L/H



Fits 5110, 5610, 6410, 6610, 6610S, 6710, 7410, 7610,
7710, 7810, 8210, 5640, 6640, 7740, 7840, 8240, 8340,
TB80, TB90, TB100, TB110, TB120, TS90, TS100, TS110,
TV140

83998749

Replaces F0NNC877BA

Lift Link End, R/H



Fits 5110, 5610, 6410, 6610, 6610S, 6710, 7410, 7610,
7710, 7810, 8210, 5640, 6640, 7740, 7840, 8240, 8340,
TB80, TB90, TB100, TB110, TB120, TS90, TS100, TS110,
TV140

HITCH

Ford / New Holland

NCA577A

Replaces 8N577A

Leveling Box Assy with Fork, R/H
Adjustment is 20.250" to 25.250"
Center Hole to Center Hole



9N564B

Leveling Assy, L/H



Fits NAA, 2N, 8N, 9N

C5NN569AN

Leveling Assembly, R/H



C5NN564D

Leveling Assembly, L/H



Fits 2000, 3000, 2600, 3600, 2310, 2610, 2910, 231, 335, 531, 3400

C5NN569AM

Leveling Assembly, R/H



C5NNB863A

Leveling Assembly, L/H



Fits 4000, 4600, 3910, 4610

D2NNN983A

Leveling Assembly, R/H



D2NNA863C

Leveling Assembly, L/H



Fits 5000, 5100, 5200, 7000, 7100, 7200, 5600, 6600, 7600, 6700, 7700

E0NN569KA

Leveling Assembly, R/H



E0NNA935AA

Leveling Assembly, L/H



Fits 5610, 6610, 7610, 6710, 7710

E4NN569BA

Leveling Assembly, R/H
For Tractors With Wet Brakes



E4NNB484AA

Leveling Assembly, L/H
For Tractors With Wet Brakes



Fits 2310, 2610, 2910, 3610, 3910, 4110, 4610, 3230, 3430, 3930, 4130, 4630, 4830, 5030, 230A, 234, 334, 335, 340, 340A, 340B, 445A, 450, 540, 540A, 540B, 545, 545A

C5NNN939A

Lower Leveling Fork Pin



Fits 5000, 5600, 5700, 6600, 6700, 7000, 7600, 7700

C5NN595B

Replaces C5NN659A
Leveling Fork Pin, 5/8" Diameter

Fits 2000, 3000, 2600, 3600, 2610, 3610



C5NN659C

Replaces C5NN659A
Leveling Fork Pin, 3/4" Diameter

Fits 4000, 4400, 4500, 445

Ford / New Holland

HITCH, STABILIZERS

5086371
Leveling Assy



Fits 3010S, 4010S, 5010S

For 3 Cylinder Tractors

D9NNB856BB
Stabilizer
Square Adjustable Type



C7NND932B
Stabilizer Bracket, L/H



C7NND933B
Stabilizer Bracket, R/H

C5NN16N321A
U-Bolt for Stabilizer Bracket



Fits 4000, 4600, 3910, 4610

For 4 Cylinder Tractors

D9NNB856AA
Stabilizer
Square Adjustable Type



C7NND932A
Stabilizer Bracket, L/H



C7NND933A
Stabilizer Bracket, R/H

388838S36
U-Bolt For Stabilizer Bracket



Fits 5000, 5100, 5200, 7000, 7100, 7200, 5600, 6600, 7600, 6700, 7700, 5610, 6610, 7610, 6710, 7710, 5640, 6640, 7740, 7840, 8240, 8340

CFPND936A
Stabilizer Assy



Fits 2000, 3000, 4000, 4600, 3910, 4610, 231, 335, 531, 340, 540, 4500

CFPND936B
Stabilizer Assy



Fits 5000, 5100, 5200, 7000, 7100, 7200, 5610, 6610, 7610, 6710, 7710

CBPN598A
Check Chain Assy



Fits 8N, 9N, NAA, 600, 700, 800, 900, 601, 701, 801, 901, 2000-4000 4 Cylinder, 2000, 3000, 2600, 3600, 2610, 2910, 3610

49A40R
Stabilizer Kit



Fits 2N, 9N, 8N, NAA, 600, 601, 611, 620, 621, 630, 631, 640, 641, 650, 651, 660, 661, 671, 681, 800, 801, 811, 820, 821, 840, 841, 850, 851, 860, 861, 871, 881, 2000-4000 4 Cylinder

HITCH & DRAWBARS

Ford / New Holland

C5NN805FSPL

Drawbar
34.625" Long, 2.00" Wide, 1.25" Thick



E4NN807AA
Replaces 81811505,
C5NN807D

Drawbar Pin and Clip



Fits 2000, 3000, 4000, 4000SU, 2600, 3600, 4600, 4600SU, 2310, 2610, 2810, 2910, 3610, 3910, 4610SU, 3230, 3430, 3930, 4130, 4630, 4830, 5030, 231, 335, 531, 340, 540, 3400, 3500, 445, 4500, 250C, 340, 340A, 340B, 345C, 345D, 445, 445A, 445C, 445D, 540, 540A, 540B, 545, 545A, 545C, 545D

CFPN820A

Drawbar Kit



Fit 2000, 3000, 2600, 3600, 2310, 2610, 2910, 3610

DRAWBARKIT02

Drawbar & Bracket Assy



C5NN805A

Drawbar (only)



Fits 5000, 7000, 5600, 6600, 6700, 7600, 7700, 5610, 6610, 6710, 7610, 7710

C7NN807C

Replaces 81816864,
C5NN807E

Drawbar Pin & Clip



Fits 5000, 7000, 5600, 6600, 7600, 7700, 5610, 6610, 7610, 7710, 7810, 7910, 8210

9N595

Rockshaft Arm Pin



Fits NAA, 2N, 8N, 9N, 600, 700, 800, 900, 601, 801, 2000-4000 4 Cylinder, 2000, 3000, 4000, 4500, 2600, 3600, 4600, 2310, 2610, 2910, 3610, 3910, 4610, Dexta, Super Dexta

E6NNN936AA

Replaces C5NNN936A

Rockshaft Arm Pin

3.79" Long



Fits 5000, 7000, 5600, 6600, 7600, 7700, 5610, 6610, 7610, 7710, 7810, 7910, 8210, 8000, 9000, 8700, 9700, TW10, TW20, TW30

C5NNN932A

Rockshaft Arm Pin

4.33" Long



Fits 5000, 7000, 5600, 6600, 7600, 7700, 5610, 6610, 7610, 7710, 7810, 7910, 8210

E2NN535BA

Top Link Bracket



Fits 4000, 4600, 4610

C7NN535C

Top Link Bracket



Fits 2000, 3000, 2600, 3600, 2310, 2610, 2800, 2910

NCA535A

Top Link Bracket



Fits 8N, 9N, 2N, NAA, 600, 700, 800, 900, 601, 701, 801, 901, 2000-4000 4 Cylinder

E4NNF537AA

Lower Lift Link Pin



Fits 4000, 5000, 7000, 5600, 6600, 7600, 5610, 6610, 7610, 7710, 7810, 7910, 8010



Ford / New Holland

REAR AXLE, DIFFERENTIAL, & BRAKES

E1NN2472BA

Replaces C5NN2472B
Brake Pedal Pull Spring

Fits 2000, 3000, 4000, 2600, 3600, 4600, 2310, 2610, 3610, 4610, 3400, 3500, 4400, 4500, 445



C5NN1126E

Brake Drum

Fits 2000, 3000, 2600, 3600, 2310, 2610, 2810, 2910, 3610, 3910, 231, 335, 3400, 3500



D9NN2N289AA

Brake Shaft Seal

Fits 2000, 3000, 2600, 3600, 2310, 2610, 2910, 3610



NCA1126A

Replaces 86533415
Brake Drum

Fits 600, 700, 800, 900, 601, 701, 801, 901, 2000-4000 4 Cylinder, 2000, 3000 (1965-3/68)



C5NN2N477A

Brake Shaft Bushing

Fits 2000, 3000, 4000, 5000, 7000, 2600, 3600, 3900, 4100, 4600, 5600, 5900, 6600, 6700, 7600, 7700, 2310, 2610, 2810, 2910, 3610, 3910, 4110, 4610, 5610, 6610, 6710, 7610, 7710, 7810, 7910, 8010, 8210, 3230, 3930, 4130, 4630, 4830, 5030, 5640, 6640, 7740, 7840, 8240, TS90, TS100, TS110. Industrials: 230A, 231, 234, 250C, 260C, 2110LCG, 334, 335, 340A, 345C, 3400, 3500, 3550, 420, 445, 450, 4400, 4500, 530A, 531, 532, 535, 540, 545, 550, 555, 5500, 650, 655, 6500, 750, 755, 7500



390777S

Replaces E94EB9
Ring Gear Bolt

380135S43

Ring Gear Nut

Fits 2000, 3000, 4000, 4000SU, 2600, 3600, 4600, 4600SU, 5600, 6600, 7600, 2310, 2610, 2810, 2910, 3610, 3910, 4610, 5000, 5100, 5200, 7000, 7100, 7200, 6700, 7700, 5610, 6610, 7610, 6710, 7710, 340, 540, 3400, 3500, 445, 4500



C5NN2N336A

Brake Rod Boot

Fits 4000, 4600, 3910, 4610, 5000, 5100, 5200, 7000, 7100, 7200, 5600, 6600, 7600 6700, 7700, 5610, 6610, 7610, 6710, 7710



C5NN1117R

Rear Axle Lug Stud

C5NN1120F

Rear Axle Lug Nut

Fits 2000, 3000, 2600, 3600, 2310, 2610, 2910, 3610



C5NN4233A

Replaces C9NN4N109A
Rear Axle Inner Seal

Fits 8N, NAA, 600, 700, 800, 900, 601, 701, 801, 901, 2000-4000 4 Cylinder, 2000, 3000, 2600, 3600, 2310, 2610, 2910, 3610, 231, 335, 531, 3400, 3500



CBPN4179A

Axle Nut and Snap Ring
Fits 8N, NAA



C5NN4115B

Rear Axle Outer Seal
3.875" O.D. for axles with nut that retains bearing.

Fits 2000, 3000, 2600, 3600, 2310, 2610, 2910, 3610, 231, 335, 531, 3400, 3500



C5NN4969D

Rear Axle Seal and Retainer

Fits 4000, 3930, 4000, 4600, 3910, 4610, 340, 540, 445, 4500



C5NN4969E

Rear Axle Seal and Retainer

Fits 5000, 5100, 5200, 7000, 7100, 7200, 5600, 6600, 7600, 6700, 7700, 5610, 6610, 7610, 6710, 7710



REAR AXLE, DIFFERENTIAL & BRAKES

Ford / New Holland

C5NN2A097B

Brake Friction Disc



C5NN2N315B

Brake Plate



D5NN2N317A

Brake Actuator Assy



Fits 4000, 4000SU, 4600, 4600SU, 2810, 2910, 3610, 3910, 4610SU, 231, 335, 531, 340, 540, 3400, 3500, 445, 4500, 250C, 340, 340A, 340B, 345C, 345D, 445, 445A, 445C, 445D, 540, 540A, 540B, 545, 545A, 545C

8N2200B

Brake Shoe Set

Priced and Sold as Set of 4



Fits 8N, NAA

NCA2218B

Brake Shoe

Priced and Sold as Set of 2



Fits 500, 600, 700, 800, 900, 501, 601, 701, 801, 901, 2000-4000 4 Cylinder

C7NN2A097B

Brake Friction Disc



C5NN2N315A

Brake Plate



C7NN2N317A

Brake Actuator Assy



Fits 5000, 5100, 5200, 7000, 7100, 7200, 5600, 6600, 7600, 5700, 6700, 7700, 5610, 6610, 7610, 6710, 7710, 7810, 8210, 5640, 6640, 7740, 7840, 8240, 8340, 7500, 750, 755A

F2NN2218AA

Replaces **C5NN2218F,**

D9NN2218AA

Brake Shoe Set

Round Adjustment Slot

Priced and Sold as Set of 2



Fits 2000, 3000, 2600, 3600, 2310, 2610, 2810, 2910, 3610, 231, 335, 3400

C5NN2218E

Brake Shoe

Square Adjustment Slot

Priced and Sold As

Individual Shoe



Fits 2000, 3000, 2600, 3600, 3400, 231

85805257

Brake Master Cylinder



Fits 555E, 575E, 655E, 675E, B110, B95, B115, B95LR, B95TC, LB110, LB110.B, LB115, LB115.B, LB75, LB75.B, LB75CP, LB90, LB90B

F0NN2140AD

Replaces **81866911,**

81869963

Brake Master Cylinder



Fits 5640, 6640, 7740, 8240, 8340, TS100, TS120, TS90



Ford / New Holland

SHEET METAL



C5NN16625F
Hood, R/H

C5NN16625G
Hood, L/H

Fits 2000, 3000, 4000, 4000SU, 3400, 3500, 4500

C7NN16625M
Hood, R/H

D3NN16626L
Hood, L/H

Fits 2600, 3600, 4600SU, 2310, 2610, 2810, 2910, 3610, 3910, 4610

C7NN16625E
Hood, R/H

C7NN16626G
Hood, L/H

Fits 5000, 5100, 5200, 7000, 7100, 7200

D5NN16N768B
Hood, R/H

D5NN16626B
Hood, L/H

Fits 5600, 6600, 7600, 5610, 6610, 7610

C5NN16N644B
Hood Handle



D4NN16N631A
Hood Hinge, L/H Bend
Fits All Late Ford and
Aftermarket Hoods

Fits 2600, 3600, 4600, 4600SU, 5600, 6600, 7600, 2310, 2610, 2810, 2910, 3610, 3910, 4610, 5600, 6600, 7600, 5610, 6610, 7610

C7NN8042A
Hood Prop Rod



Fits 2000, 3000, 4000, 4000SU, 5000, 7000, 2600, 3600, 4600, 4600SU, 5600, 6600, 7600, 7700, 2310, 2610, 2810, 2910, 3610, 3910, 4610SU, 5610, 6610, 7610, 7810, 5900, 231, 335, 531, 340, 540, 3400, 3500, 445, 4500, 250C, 340, 340A, 340B, 345C, 345D, 445, 445A, 445C, 445D, 540, 540A, 540B, 545, 545A, 545C, 545D

D8NN9661AA
Replaces **D0NN9661B,**
D1NN9661A, D5NN9661A,
D8NN9661BA
Air Cleaner Cover Assy



Fits 2600, 3600, 4600, 5600, 5700, 6600, 6700, 7600, 7700, 230A, 231, 234, 334, 335, 340A, 340B, 530A, 531, 540A, 540B

C5NE9661A
Air Cleaner Cover



Fits 2000, 3000, 4000, 2600, 2600, 2600, 2310, 2610, 2901, 3610, 3910, 4610 All Gas, 3400, 4400, 4500, 231, 335, 420, 515, 531, 532, 535, 540, 545 Gas and Diesel

SHEET METAL

Ford / New Holland

E4NN16A858AA

Nose Cone



Fits 2310, 2610, 2910, 3610, 3910, 4610, 5610, 6610, 7610, 7810

D0NN8N202K-1PC

Grille Shell for Oil Bath Air Filter



Uses 1 Piece
Metal/Plastic Grille

Fits 4000, 5000

D4NN8N202D-1PC

Grille Shell for Oil Bath Air Filter



Uses 1 Piece
Metal/Plastic Grille

Fits 2000, 3000, 4000SU

D0NN8N202K-2PC

Grille Shell for Oil Bath Air Filter



Uses 2 Piece Plastic Grille

Fits 4000, 5000

D4NN8N202D-2PC

Grille Shell for Oil Bath Air Filter



Uses 2 Piece Plastic Grille

Fits 2000, 3000, 4000SU

D5NN8N202A

Grille Shell for Dry Air Cleaner



Uses 1 Piece Grille

Fits 4600 All Purpose, 5600, 6600, 7600

D4NN8N202E

Replaces D5NN8N202B
Grille Shell for Dry Air Cleaner



Uses 1 Piece Grille

Fits 2600, 3600, 4600SU

C5NN16N655A

Replaces D8NN8N119AA
Rubber Support



Fits 2000, 3000, 4000, 4000SU, 5000, 7000, 2600, 3600, 4600, 4600SU, 5600, 6600, 7600, 7700, 2310, 2610, 2810, 2910, 3610, 3910, 4610SU, 5610, 6610, 7610, 7810, 5900, 3230, 3430, 3930, 4130, 4630, 4830, 5030, 5640, 6640, 7740, 7840, 8240, 8000, 9000, 8600, 9600, 9700, TW5, TW10, TW15, TW20, TW25, TW30, TW35, 231, 335, 531, 340, 540, 3400, 3500, 445, 4500, 250C, 340, 340A, 340B, 345C, 345D, 445, 445A, 445C, 445D, 540, 540A, 540B, 545, 545A, 545C, 545D, 550, 555, 555A, B, C, 655, 655A, B, C, D

Ford / New Holland

SHEET METAL

C9NN8A163AG

Top Grille (Plastic)



D1NN8151A

Bottom Grille (Plastic)

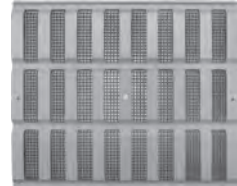

C9NN8B151B

Grille Knob



C7NN8A067A

Grille Clip



D1NN8151B

Bottom Grille (Plastic)
With Headlight Holes

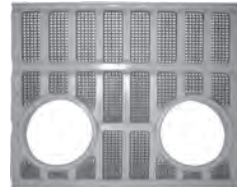

Fits 2000, 3000, 4000, 4000SU, 5000, 5100, 5200, 7000, 7100, 7200, 3400

E4NN8138AA

Replaces **D5NN8A133A98G,**
E0NN8138EC
Grille With Screen



Fits 6710, 7710, 7810, 7910, 8210
01/01/1985 and up (will work on
5700, 6700, 7700, and Early 6710,
7710, 7810, 7910, 8210, but is not
drilled for letters)

D5NN8200C

One Piece Grille
with Headlight Holes



D4NN8N213A

Grille Knob Bolt & Clip



D5NN8200A

One Piece Grille



Fits 2600, 3600, 4600, 4600SU, 5600, 6600, 7600

C5NN8A163A

Top Grille
1965-1968



C5NN8202AA

Bottom Grille
1965-1968



Fits 2000, 3000, 4000, 4000SU, 5000, 5100, 5200, 7000, 7100, 7200, 3400

E1NN8200AA

Front Grille
with Headlight Holes

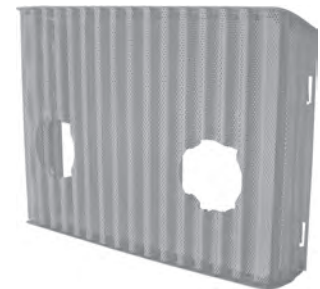

Fits 2310, 2610, 2810, 2910, 3610, 3910, 4610, 5610, 6610, 7610

D9NN8A134AA

Side Grille Panel, R/H
With Screen



D9NN8A135AA

Side Grille Panel, L/H
With Screen

Fits 5700, 6700, 7700, 6710, 7710, 7810, 7910, 8210, 8700, 9700, TW5, TW10, TW15, TW20



SHEET METAL

Ford / New Holland

E0NN8200AA

Front Grille
With Headlight Holes



Fits 2310, 2610, 2810,
2910, 3610, 3910, 4610,
5610, 6610, 7610

310984

Outer Grille



8N8204

Grille



Fits 8N, 9N, 2N

310982

Inner Grille



8N16618

Side Panel, R/H



8N16619

Side Panel, L/H



Fits 2N, 8N, 9N

310032

Lower Grille Panel



Fits 801, 4030, 4031

C3NN16652B

Hood Side Panel, R/H



C3NN16653B

Hood Side Panel, L/H

Fits NAA, 600, 700, 800, 900, 2000-4000 4 Cylinder

957E8163A

Grille Screen, R/H
Without Headlight Holes



957E8164A

Grille Screen, L/H
Without Headlight Holes

Fits Dexta, Super Dexta

957E8163B

Grille Screen, R/H
With Headlight Holes



957E8164B

Grille Screen, L/H
With Headlight Holes

Fits Dexta, Super Dexta

Ford / New Holland

SHEET METAL

C0NN16312A

Fender with Bracket
R/H & L/H



Fits 8N, 9N, 2N, NAA

957E16312A

Fender, R/H



957E16313C

Fender, L/H

Fits Dexta, Super Dexta

E1NN16315DA

Fender Skin



C5NN16312AK

Fender with Bracket
R/H & L/H



Fits 2000, 3000, 4000, 4000SU, 2310, 2610, 2810, 2910, 3610, 3910, 4610, 231, 335, 531, 340, 540, 3400, 3500, 445, 4500, 8N, 9N, 2N, NAA, 600, 700, 800, 900, 601, 701, 801, 901, 2000-4000 4 Cylinder

E5NN16313DA

Fender, L/H

D8NN16312ABB

Fender, R/H



Fits 2600, 2610, 2810, 2910, 335, 3600, 3610, 3910, 3930, 4000, 4100, 4110, 420, 4600, 4600SU, 4610, 4610SU, 4630, 4830, 5030, 515, 532, 535, 5600, 5610, 6600, 6610, 7600, 7610

D3NN16N319D

Fender Bracket
For R/H or L/H Flat Top Fender
18" Wide x 17" Tall

Fits 4000, 4000SU, 2600, 3600, 4600, 4600SU, 2610, 2910, 3610, 3910, 4610, 4610SU



D3NN16N319C

Fender Bracket
For R/H or L/H Flat Top Fender
18" Wide x 23" Tall

Fits 5000, 5100, 5200, 7000, 7100, 7200, 5600, 6600, 7600, 6700, 7700, 5610, 6610, 7610

D3NN17005B

Tool Box



Fits all Ford Tractors



SHEET METAL

Ford / New Holland

C5NN16451BV

Running Board, L/H



C5NN16450N

Running Board, R/H

Fits 2000, 3000, 2600, 3600, 2310, 2610, 2910, 3610

8N10732

Battery Box



Fits 8N

957E16472A

Running Board, R/H

957E16473B

Running Board, L/H



Fits Dexta, Super Dexta

C0NN10732T

Battery Box
For Gas Tractors



Fits NAA, 600, 700, 800, 900, 501, 601, 701, 801, 901,
2000-4000 4 Cylinder

353873S

Rubber Grommet
For Throttle Lever



Fits NAA, 600, 700, 800, 900, 601, 701, 801, 901,
2000-4000 4 Cylinder

C5NN10723H

Battery Tray
For Diesel Tractors



Fits 2000, 3000, 4000, 4000SU, 2600, 3600, 4600,
4600SU, 5600, 6600, 7600, 2310, 2610, 2810, 2910,
3610, 3910, 4610, 5000, 5100, 5200, 7000, 7100, 7200,
5610, 6610, 7610, 231, 335, 531, 340, 540, 3400, 3500,
445, 4500



Ford / New Holland

WHEELS & RIMS

C5NN1015A

Front Wheel
4" x 19"
6 Lug



Fits 8N

WHEEL26

Replaces E0NN1007LA,
C7NN1007H,
D2NN1007J,
C7NN1007L,
C9NN1007E,
E0NN1007GA12G
Front Wheel 8.00" x 16"
For 10.00" x 16" Tire



Fits 5000, 5100, 5200, 7000, 7100, 7200, 5600, 6600,
7600, 6700, 7700, 5610, 6610, 7610, 6710, 7710, 335,
531, 340, 540, 3400, 3500, 445, 4500

9N1015A

Front Rim
4" x 19"
5 Lug



Fits 9N, 2N

WEIGHT01

Front Wheel Weight
40 LBS



Fits Most 16" Front Rims

WHEEL01

Replaces 8N1015C,
C5NN1N015A,
E6NN1007AA,
E6NN1007LA,
E9NN1007SA
Front Wheel 4.5" x 16"
For 6.00" x 16" Tire



WHEEL02

Replaces E6NN1007BA,
D2NN1007S,
D2NN100729Z
Front Wheel 5.5" x 16"
For 7.50" x 16" Tire



Fits 8N, NAA, 600, 700, 800,
900, 601, 701, 801, 901, 2000-
4000 4 Cylinder, 2000, 3000, 4000, 4000SU, 2600, 3600,
4600, 4600SU, 5000, 5100, 5200, 7000, 7100, 7200, 5600,
6600, 7600, 6700, 7700, 5610, 6610, 7610, 6710, 7710,
2310, 2610, 2810, 2910, 3610, 3910, 4610, 231, 335, 531,
340, 540, 3400, 3500, 445, 4500

WHEELS & RIMS

Ford / New Holland

WHEEL03

Replaces D9NN1050CA,
D9NN1050BA, C0NN1050F
Rear Rim 10" x 28"
6 Loop

WHEEL04

Replaces D9NN1050DA,
C7NN1050M,
D2NN1050G,
E5NN1050JA,
E5NN1050JA12G,
D4NN1050B
Rear Rim 11" x 28"
6 Loop



WHEEL05

Replaces 313197, 31319729Z, D9NN1050EA,
C7NN1050N, D0NN1050A, D4NN1050E,
D5NN1050A, D4NN1050B, D9NN1050FA
Rear Rim 12" x 28"
6 Loop

WHEEL19

Replaces 1861894M91, 373508R91, AL2452,
AL36059, AL36059, AL63463
Rear Rim 13" x 28"
6 Loop

Fits 8N, NAA, 600, 700, 800, 900, 601, 701, 801, 901,
2000-4000 4 Cylinder, 2000, 3000, 4000, 4000SU, 2600,
3600, 4600, 4600SU, 5000, 5100, 5200, 7000, 7100,
7200, 5600, 6600, 7600, 6700, 7700, 5610, 6610, 7610,
6710, 7710, 2310, 2610, 2810, 2910, 3610, 3910, 4610,
231, 335, 531, 340, 540, 3400, 3500, 445, 4500

WHEEL18

Replaces D4NN1050G,
D2NN1050J
Rear Rim 14" x 30"



WHEEL30

Replaces D9NN1050GA,
C5NN1100AE,
D2NN1150L
Rear Rim 15" x 30"

WHEEL34

Replaces C5NN1036K
Rear Wheel Center
30" 8 Bolt

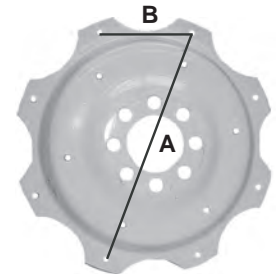

Mounting Bolt Pattern May
Be Different Than OEM

Check Measurements
Before ordering
A = 25 1/4"
B = 9 5/8"

Fits 4000, 5000, 7000, 4600, 5600, 6600, 7600, 3910,
4610, 5610, 6610, 7610, 3230, 3430, 3930, 4630, 5640,
6640, 7740, 340, 540, 4400, 4500, 445, 455, 555, 655

BOLTKIT01

Bolt & Nut, Fiat Style
2 1/2" Long



BOLTKIT02

Bolt & Nut, MF Style
3" Long



BOLTKIT03

Bolt & Nut, Ford Style
3" Long



BOLTKIT04

Bolt & Nut, JD Style
4 3/4" Long



Ford / New Holland

SEATS, MISC

PM-11

Blue Seat
With Slide Track



PA-11

Black Seat
With Slide Track



BT-116B

Black Seat
With Slide Track
Without Arm Rests



Fits Most Ford Tractors

7704900

Swing Chain, R/H
Short Link-Short Link



Fits 3400, 3500, 4400, 4500, 550, 650, 6500, Backhoe
Models 19-388, 19-389, 19-390, 19-480, 19-481, 19-482,
19-551, 19-552, 19-635, 19-637, 19-715, 750, 753, 755

7704901

Swing Chain, L/H
Short Link-Long Link



Fits 3400, 3500, 4400, 4500, 550, 650, 6500, Backhoe
Models 19-388, 19-389, 19-390, 19-480, 19-481, 19-482,
19-551, 19-552, 19-635, 19-637, 19-715, 750, 753, 755



SHOP MANUALS

Ford / New Holland



ITFO4

I&T FO-4 Ford Shop Manual

Fits 2N, 8N, 9N



ITFO19

I&T FO-19 Ford Shop Manual

Fits NAA (Jubilee)



ITFO20

I&T FO-20 Ford Shop Manual

Fits Gas and Diesel Models: 501, 600, 601, 700, 701, 800, 801, 900, 901, 1801, 2030, 2031, 2110, 2111, 2120, 2130, 2131, 4030, 4031, 4040, 4110, 4120, 4121, 4130, 4131, 4140



ITFO31

I&T FO-31 Ford Shop Manual

Fits Series 2000 (3-Cylinder), 3000 (3-Cylinder), 4000 (3-Cylinder) Models Pre-1975: 2100 All Purpose, 2110 L.C.G., 3100 All Purpose, 4100 All Purpose, 4110 L.C.G., 4140 S.U., 4200 Row Crop



ITFO41

I&T FO-41 Ford Shop Manual

Fits 2310, 2600, 2610, 3600, 3610, 4100 (After 1974), 4110, 4600, 4610 (Prior To 1984), 4600SU, 4610SU (Prior To 1984)



ITFO42

I&T FO-42 Ford Shop Manual

Fits Gasoline Models: 5100, 5200, 6600, 6700, 7100, 7200; Diesel Models: 5100, 5200, 5600, 5610, 6600, 6610, 6700, 6710, 7100, 7200, 7600, 7610, 7700, 7710; Includes Wiring Diagrams for: 5100, 5200, 7100 and 7200 Models



ITFO43

I&T FO-43 Ford Shop Manual

Fits 2810, 2910, 3910



ITFO44

I&T FO-44 Ford Shop Manual

Fits 1100, 1110, 1200, 1210, 1300, 1310, 1500, 1510, 1700, 1710, 1900, 1910, 2110



ITFO45

I&T FO-45 Ford Shop Manual

Fits Diesel Models TW-5, TW-15, TW-25, TW-35



ITFO46

I&T FO-46 Ford Shop Manual

Fits Diesel Models 1120, 1220, 1320, 1520, 1720, 1920, 2120



ITFO47

I&T FO-47 Ford Shop Manual

Fits Diesel Models 3230, 3430, 3930, 4630, 4830



ITFO48

I&T FO-48 Ford Shop Manual

Fits 5640, 6640, 7740, 7840, 8240, 8340



ITFO201

I&T FO-201 Ford Shop Manual

Fits Fordson Dexta; FMD; FPM; FSM; 5000 Super Major; Series 6000; Commander 6000; Series 1000, 1600; Models 8000, 8600, 8700, 9000, 9600, 9700, TW-10, TW-20, TW-30

